

**27VNA0 Infinity®
Variable Speed Heat Pump
with Greenspeed® Intelligence
and Puron Advance™ (R-454B) Refrigerant
2 to 5 Nominal Tons**



Turn to the experts

Installation Instructions

NOTE: Read the entire instruction manual before starting the installation.

Unit **MUST** be installed with rated R-454B indoor with factory approved dissipation control board installed.

	PAGE NO.		PAGE NO.
SAFETY CONSIDERATIONS	2	Utility Interface With Infinity® Control	16
VFD Cover	2	Infinity® Control, Green Communications (COMM) Light ...	16
General	3	Amber Status Light.....	17
Installation	3	5x7 LED Matrix	17
Step 1 – Check Equipment and Job Site	4	VFD Communications Light	17
Unpack Unit	4	Bluetooth® Module	17
Inspect Equipment	4	Variable Frequency Drive (VFD).....	17
Step 2 – Install on a Solid, Level Mounting Pad	4	Table 6 – VFD LED Indicator Functions	17
Step 3 – Clearance Requirements	4	Input Filter Board	18
Step 4 – Operating Ambient	4	Reactors	18
Step 5 – Elevate Unit	4	Variable Speed Compressor	18
Step 6 – Make Piping Connections	5	Time Delays	18
Table 1 – Refrigerant Connections and Recommended Liquid and Va-		Heating Electronic Expansion Valve (EXV-H)	18
por Tube Diameters (in.)	5	Variable Speed Fan Motor	18
Outdoor Unit Connected to Factory-Approved		Pressure Equalization Valve (PEV)	18
R-454B Indoor Unit	6	High Pressure Switch	18
Mechanical Line Set Connections	6	Outdoor Pressure Transducers	18
Install Liquid-Line Filter Drier - Indoor	6	Stator Heater Operation	18
Refrigerant Tubing Connection - Outdoor	6	Infinity® Controlled Low Ambient Cooling	18
No Installation of Adapter Tube	6	Defrost	18
Sweat Connections	6	Troubleshooting	19
Pressure Test Tubing and Indoor Coil	6	Systems Communication Failure	19
Evacuate Refrigerant Tubing and Indoor Coil	7	Model Plug	19
Deep Vacuum Method	7	Table 7 – Model Plug Information	19
Mandatory Requirements	7	Pressure Switch Protection	19
Pressure Proof Check	7	Compressor Protection	19
Leak Check	7	Line Voltage Diagnostics	19
Final Tubing Check	7	Forced Defrost Pins	19
Step 7 – Make Electrical Connections	7	Temperature Thermistors	19
Route Ground and Power Wires	7	Table 8 – 10K Thermistor Resistance Values	19
Connect Ground and Power Wires	7	Table 9 – 50K Thermistor Resistance Values	19
Connect Control Wiring	7	Outdoor Air Temperature (OAT)	19
General Information	8	Outdoor Coil Temperature (OCT-HP)	20
Final Wiring Check	8	Liquid Line Temperature (LLT-HP)	20
Step 8 – Compressor Stator Heat	8	Outdoor Suction Temperature (OST)	20
Step 9 – Install Accessories	8	Outdoor Discharge Line Temperature (ODT)	20
Step 10 – Start-Up & Charging	8	Failed Thermistor Default Operation	21
Table 2 – Environment Type Guideline	9	Variable Speed Compressor Winding Resistance	21
Table 3 – Standard Subcooling Values	9	Table 10 – Variable Speed Compressor Resistances	
Setup for Infinity® Control		winding resistance at 68°F (20°F)	21
Furnace or FE Fan Coil (communicating)	9	Fan Motor	21
Follow these steps to properly start up the system	9	Status Codes	21
Table 4 – Required Liquid Line Temperature for R-454B	11	Status Code Recall Mode	21
Check Charge - Cooling / Heating	12	Table 11 – Diagnostic Code Table	22
Post Charging	13	Table 12 – Malfunction Lockout Durations	23
Table 5 – Minimum Room Area Charging Table	13	FINAL CHECKS	24
Step 11 – Pump Down & Evacuation	13	REPAIRING REFRIGERANT CIRCUIT	24
Evacuation and Recovery of Refrigerant from within 27VNA0		CARE AND MAINTENANCE	24
14		Puron Advance™ (R-454B) Refrigerant — Quick Reference Guide	25
Step 12 – System Functions and Major Components	15		
Primary Control Module	15		

SAFETY CONSIDERATIONS

This appliance shall only be installed by EPA qualified personnel and have Section 608 Technician Certification. This appliance is not intended for use by persons (including children) with reduced physical, sensory, or mental capabilities, or lack of experience and knowledge, unless they have been given supervision or instruction concerning use of the appliance by a person responsible for their safety.

Improper installation, adjustment, alteration, service, maintenance, or use can cause explosion, fire, electrical shock, or other conditions which may cause death, personal injury, or property damage. Consult a qualified installer, service agency, or your distributor or branch for information or assistance. The qualified installer or agency must use factory-authorized kits or accessories when modifying this product. Refer to the individual instructions packaged with the kits or accessories when installing.

Follow all safety codes. Wear safety glasses, protective clothing, and work gloves. Use quenching cloth for brazing operations. Have a dry powder or CO₂ fire extinguisher available. Read these instructions thoroughly and follow all warnings or cautions included in literature and attached to the unit. Consult local building codes and current editions of the National Electrical Code (NEC) NFPA 70. In Canada, refer to current editions of the Canadian electrical code CSA 22.1.

Proper tools should be used that are designed for the refrigerant of the unit being installed. For A2L refrigerants, non-sparking tools are required. A refrigerant detector should be used prior to and during the installation process to check for leaks. Open flames or other ignition sources should not be present except during brazing. Brazing should only take place on refrigerant tubes that are open to the atmosphere or have been properly evacuated.

Recognize safety information. This is the safety-alert symbol . When you see this symbol on the unit and in instructions or manuals, be alert to the potential for personal injury. Understand these signal words: WARNING, and CAUTION. These words are used with the safety-alert symbol. WARNING signifies hazards which could result in personal injury or death. CAUTION is used to identify unsafe practices which would result in minor personal injury or product and property damage. NOTE is used to highlight suggestions which will result in enhanced installation, reliability, or operation.

 **WARNING**



EXPLOSION HAZARD

Failure to follow this warning could result in death, serious personal injury, and/or property damage.

Never use air or any gas containing oxygen for leak testing or operating refrigerant compressors. Pressurized mixtures of air or gases containing oxygen can lead to an explosion. Never allow compressor suction pressure to operate in a vacuum with service valves closed. See service manual for pump-down instructions.

 **CAUTION**

CUT HAZARD

Failure to follow this caution may result in personal injury. Sheet metal parts may have sharp edges or burrs. Use care and wear appropriate protective clothing and gloves when handling parts.

 **WARNING**

ELECTRICAL SHOCK HAZARD

Failure to follow this warning could result in personal injury or death. Before installing, modifying, or servicing system, main electrical disconnect switch must be in the OFF position. There may be more than 1 disconnect switch. Lock out and tag switch with a suitable warning label.

 **WARNING**

PERSONAL INJURY AND ENVIRONMENTAL HAZARD

Failure to follow this warning could result in personal injury or death. Do not use means to accelerate the defrosting process or to clean, other than those recommended by the manufacturer. The appliance shall be stored in a room without continuously operating ignition sources (for example: open flames, an operating gas appliance or an operating electric heater. Do not pierce or burn. Be aware that refrigerants do not contain an odor.

 **WARNING**

ELECTRICAL HAZARD - HIGH VOLTAGE!

Failure to follow this warning could result in personal injury or death. Electrical components may hold charge. **DO NOT** remove control box cover for 2 minutes after power has been removed from unit. **PRIOR TO TOUCHING ELECTRICAL COMPONENTS:** Verify zero (0) voltage at VFD connections shown on control box cover.

VFD Cover
IMPORTANT: The VFD cover should NEVER be removed because VFD components are not serviceable. The VFD can be removed from unit with cover installed.

 **WARNING**

UNIT OPERATION AND SAFETY HAZARD

Failure to follow this warning could result in personal injury or equipment damage. Puron Advance™ (R-454B) refrigerant systems operate at higher pressures than standard R-22 and similar pressures to R-410A systems. Do not use R-22 or R-410A service equipment or components on Puron Advance™ (R-454B) refrigerant equipment.

Indoor Thermostat Control Options

Model	Infinity® Control
27VNA0	Yes*

*Requires latest infinity® System Control software version

General

Acronyms used in this publication

Acronym	Description
PCM	Primary Control Module
VFD	Variable Frequency Drive
DPT	Discharge Pressure Transducer
SPT	Suction Pressure Transducer
ODT	Outdoor Discharge Line Temperature
OST	Outdoor Suction Temperature
OCT	Outdoor Coil Temperature
LLT	Liquid Line Temperature
OAT	Outdoor Air Temperature
PEV	Pressure Equalization Valve
RVS	Reversing Valve
CCN	Carrier Communication Network
EXV-H	Heating Electronic Expansion Valve

NOTE: In some cases noise in the living area has been traced to gas pulsations from improper installation of equipment.

1. This unit is intended to be installed in a location that is 10,000 feet (3000 meters) above sea level or lower.
2. Locate unit away from windows, patios, decks, etc. where unit operation sound may disturb customer.
3. Variable speed units have a wide airflow range. Consider ductwork limitations at both high and low airflows.
4. In noise sensitive applications (such as bedrooms), when a lineset is mounted to ceiling joists or floor joists, the outdoor unit must be located at least 10 ft (3.05 m) away. If this is not possible, create a line set configuration with enough bends to provide 10 ft (3.05 m) of total line set length outside the dwelling.
5. Ensure that vapor and liquid tube diameters are appropriate for unit capacity (see [Table 1](#)).
6. Run refrigerant tubes with no bends with centerline bend radius less than 2.5 times the external pipe diameter.
7. Leave some slack between structure and unit to absorb vibration.
8. When passing refrigerant tubes through the wall, seal opening with RTV or other pliable silicon-based caulk (see [Fig. 1](#)).
9. Avoid direct tubing contact with water pipes, duct work, floor joists, wall studs, floors, and walls.
10. Do not suspend refrigerant tubing from joists and studs with a rigid wire or strap which comes in direct contact with tubing (see [Fig. 1](#)).
11. Ensure that tubing insulation is pliable and completely surrounds vapor tube.
12. When necessary, use hanger straps which are 1 in. (25 mm) wide and conform to shape of tubing insulation. (See [Fig. 1](#))
13. Isolate hanger straps from insulation by using metal sleeves bent to conform to shape of insulation.
14. Provision shall be made for expansion and contraction of long runs of piping.
15. Piping and fittings shall be protected as far as possible against adverse environmental effects. For example, the accumulation of dirt and debris.
16. Piping should be installed to reduce the likelihood of hydraulic shock damaging the system.
17. Certified piping and components must be used in order to protect against corrosion.
18. Flexible pipe elements shall be protected against mechanical damage, excessive stress by torsion, or other forces. They should be checked for mechanical damage annually.
19. Piping material, routing, and installation shall include protection from physical damage in operation and service, and be in compliance with the national and local codes and standards of the installation site.
20. When setting up refrigerant piping, precautions shall be taken to avoid excessive vibration or pulsation.

! CAUTION

EQUIPMENT DAMAGE HAZARD

Failure to follow this caution may result in equipment damage. If proper lineset routing techniques are not followed, variable speed systems can be susceptible to lineset transmitted noise inside the dwelling and, in extreme cases, tubing breakage.

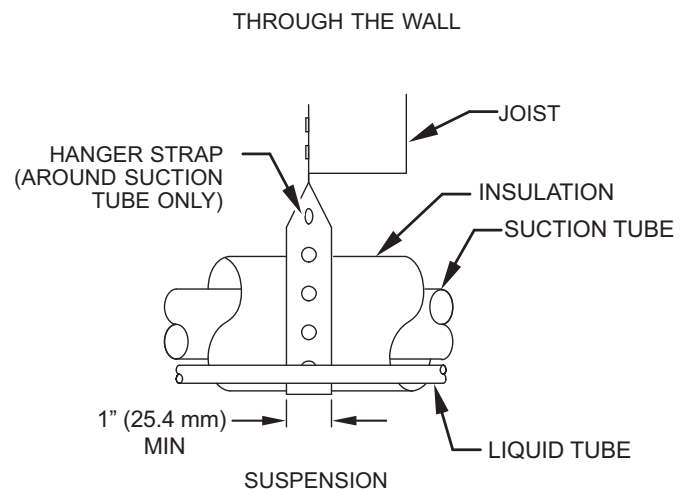
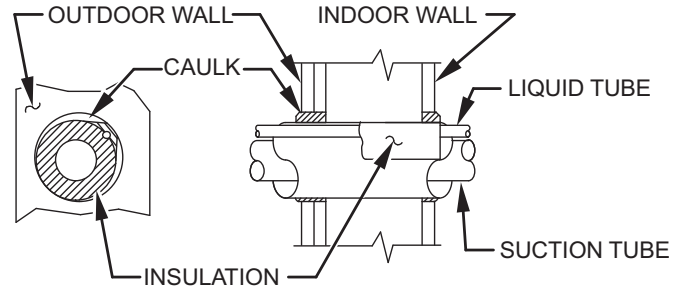

Fig. 1 – Connecting Tubing Installation

A07588

The outdoor unit contains the correct amount of refrigerant charge for operation with AHRI rated and factory-approved smallest indoor unit when connected by 15 ft (4.57 m) of field-supplied or factory accessory tubing.

Adjust refrigerant charge by adding or removing the charge to/from the unit depending on lineset length and indoor unit as calculated and displayed on the Infinity® System Control. The Infinity® System Control calculates required charge adjustment and total system charge required. For proper unit operation, check refrigerant charge using charging information in the Startup & Charge section of this instruction.

IMPORTANT: Liquid-line size is 3/8-in. OD for all 27VNA0 applications including long line applications. Refer to Residential Piping and Long Line Guideline for further information.

IMPORTANT: Always install the factory-supplied liquid-line filter drier. Obtain replacement filter driers from your distributor or branch.

Installation

IMPORTANT: All split system and packaged heat pumps must be installed pursuant to applicable regional efficiency standards issued by the Department of Energy.

Specifications for this unit in residential new construction market require the outdoor unit, indoor unit (including metering device), refrigerant tubing sets, and filter drier, and muffler listed in pre-sale literature. There can be no deviation. Consult the Application Guideline and Service Manual - Air Conditioners and Heat Pumps using Puron Advance™ (R-454B) Refrigerant.

Step 1 – Check Equipment and Job Site

Unpack Unit

Move to final location. Remove carton taking care not to damage unit. This unit employs louver spacers on each of the four sides to prevent louver movement during operation. The louver spacers are installed between the coil surface and louver at the approximate center of each side (See Fig. 2). This louver spacer should be present and, if dislodged during shipment, must be reinstalled before unit is placed into operation. **NOTE:** 2 Ton units use only two louver spacers on the sides opposite the control box.

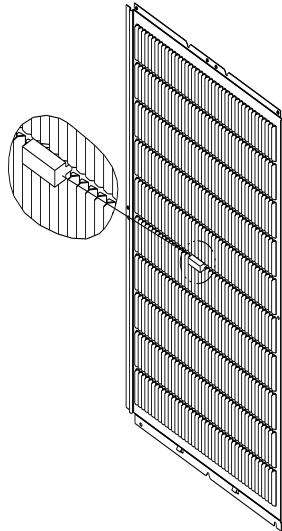

A11380a

Fig. 2 – Louver Spacer Location

Inspect Equipment

File claim with shipping company prior to installation if shipment is damaged or incomplete. Locate unit rating plate on unit corner panel. It contains information needed to properly install unit. Check rating plate to be sure unit matches job specifications.

Step 2 – Install on a Solid, Level Mounting Pad

If conditions or local codes require the unit be attached to pad, tie down bolts should be used and fastened through knockouts provided in unit base pan. Refer to unit mounting pattern in Fig. 3 to determine base pan size and knockout hole location.

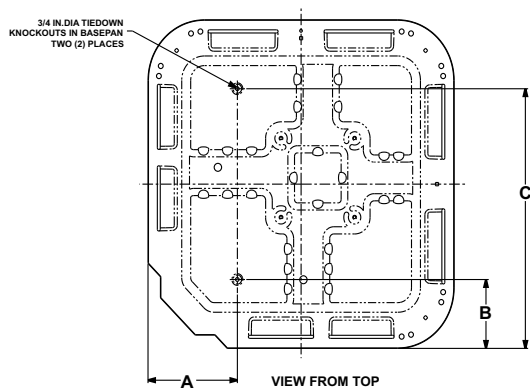

UNIT SIZE	UNIT BASE PAN Dimension in. (mm)	TIEDOWN KNOCKOUT LOCATIONS in. (mm)		
		A	B	C
2 Ton	23 X 23 (584 X 584)	7-13/16 (198)	4-7/16 (113)	18-1/8 (460)
3 Ton	31.2 X 31.2 (792 X 792)	9-1/8 (231.8)	6-9/16 (166.7)	28-7/16 (722.3)
4 & 5 Ton	35 X 35 (889 X 889)	9-1/8 (231.8)	6-9/16 (166.7)	28-7/16 (722.3)

A05177

Fig. 3 – Tie-down Knockout Locations

For hurricane tie downs, contact distributor for details and PE (Professional Engineer) Certification, if required.

On rooftop applications, mount on level platform or frame. Place unit above a load-bearing wall and isolate unit and tubing set from structure. Arrange supporting members to adequately support unit and minimize transmission of vibration to building. Consult local codes governing rooftop applications.

Roof mounted units exposed to winds above 5 mph may require wind baffles. Consult the Service Manual - Residential Split System Air Conditioners and Heat Pumps Using Puron Advance™ (R-454B) Refrigerant for wind baffle construction.

NOTE: Unit must be level to within ±2° (±3/8 in./ft, ±9.5 mm/m.) per compressor manufacturer specifications.

Step 3 – Clearance Requirements

When installing, allow sufficient space for airflow clearance, wiring, refrigerant piping, and service. Allow 24 in. (609.6 mm) clearance to service end of unit and 48 in. (1219.2 mm) above unit. For proper airflow, a 6-in. (152.4 mm) clearance on 1 side of unit and 12-in. (304.8 mm) on all remaining sides must be maintained. Maintain a distance of 24 in. (609.6 mm) between units. Position so water, snow, or ice from roof or leaves cannot fall directly on unit.

On rooftop applications, locate unit at least 6 in. (152.4 mm) above roof surface.

Step 4 – Operating Ambient

The minimum outdoor operating ambient in cooling mode is 55°F (12.78°C) without low ambient cooling enabled in the Infinity® System Control.

The minimum outdoor operating ambient in heating mode is -11°F (-23.9°C).

Step 5 – Elevate Unit

Elevate unit per local climate and code requirements to provide clearance above estimated snowfall level and ensure adequate drainage of unit.

! CAUTION

UNIT OPERATION HAZARD

Failure to follow this caution may result in equipment damage or improper operation.

Do not allow water and/or ice to build up in base pan.

! CAUTION

UNIT OPERATION HAZARD

Failure to follow this caution may result in equipment damage or improper operation.

Locate the unit in such a way that it is stable in all circumstances including adverse weather conditions.

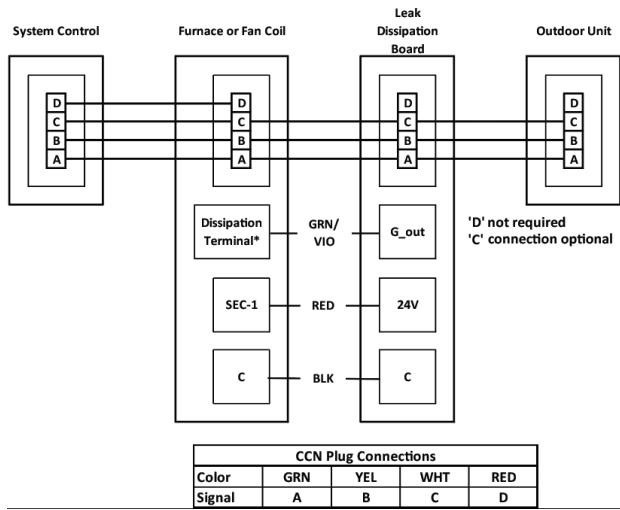

Fig. 4 – Infinity® Furnace or Fan Coil Wiring with Communicating Variable Speed HP

Step 6 – Make Piping Connections

! WARNING

PERSONAL INJURY AND ENVIRONMENTAL HAZARD

Failure to follow this warning could result in personal injury or death. Relieve pressure and recover all refrigerant before system repair or final unit disposal. Use all service ports and open all flow-control devices, including solenoid valves. Federal regulations require that refrigerant is not vented into the atmosphere. Recover during system repair or final unit disposal.

! CAUTION

UNIT DAMAGE HAZARD

Failure to follow this caution may result in equipment damage or improper operation. Do not leave system open to atmosphere any longer than minimum required for installation. PVE oil in compressor is extremely susceptible to moisture absorption. Always keep ends of tubing sealed during installation.

! CAUTION

UNIT DAMAGE HAZARD

Failure to follow this caution may result in equipment damage or improper operation. If ANY refrigerant tubing is buried, provide a 6 in. (152.4 mm) vertical rise at service valve. Refrigerant tubing lengths up to 36 in. (914.4 mm) may be buried without further special consideration. Do not bury lines longer than 36 in. (914.4 mm).

Outdoor units may be connected to indoor section using accessory tubing package or field-supplied refrigerant grade tubing of correct size and condition. Federal regulations require that refrigerant is not vented into the atmosphere. Recover during system repair or final unit disposal. For tubing requirements beyond 80 ft. (24.38 m), substantial capacity and performance losses can occur. Follow the pipe sizing recommendations in the 27VNA0Product Data to manage these losses.

Refer to **Table 1** for field tubing diameters. Refer to the Product Data for accessory requirements.

Refrigerant pipe should be installed with the minimum length possible and practical for the application. Piping should be protected from physical damage in operation and in service and be in compliance with national and local codes such as ASHRAE 15, ASHRAE 15.2, IAPMO Uniform Mechanical Code, ICC International Mechanical Code, or CSA B52. When piping is installed through studs in a wall, steel plates should be used for protection with a minimum thickness of 16 gauge.

All field joints shall be accessible for inspection prior to being covered or enclosed.

Table 1 – Refrigerant Connections and Recommended Liquid and Vapor Tube Diameters (in.)

UNIT SIZE	LIQUID		VAPOR*		
	Connection Diameter	Tube Diameter	Connection Diameter	Max (Rated) Diameter	Minimum Tube Diameter
27VNA024	3/8	3/8	3/4	3/4	5/8
27VNA036	3/8	3/8	7/8	7/8	5/8
27VNA048	3/8	3/8	7/8	1-1/8† (7/8)	3/4
27VNA060	3/8	3/8	7/8	1-1/8†	3/4

*.Units are rated with 25 ft. (7.6 m) of lineset. See Product Data sheet for performance data when using different size and length line sets.

†.Required maximum diameter for applications using greater than 25 ft. (7.6 m) of lineset is 7/8 in.

Notes:

1. Do not apply capillary tube indoor coils to these units.

Outdoor Unit Connected to Factory-Approved R-454B Indoor Unit

When outdoor unit is connected to factory-approved R-454B indoor unit, the outdoor unit contains correct system refrigerant charge for operation with smallest factory-approved, AHRI-rated indoor unit when connected by 15 ft. (4.57 m) of field-supplied or factory-accessory tubing, and factory-supplied filter drier. Check refrigerant charge for maximum efficiency.

NOTE: If the indoor furnace coil width is more than the furnace casing width, refer to the indoor coil Installation Instructions for transition requirements.

Mechanical Line Set Connections

If using mechanical or crimp-type line set connections, follow crimp tool manufacturer's instructions.

NOTE: Should the use of mechanical fittings cause failure of the fittings or failure of the equipment, such would not be covered under the standard warranty.

Install Liquid-Line Filter Drier - Indoor

Refer to Fig. 5 and install filter drier as follows:

1. Braze 5-in. (127 mm) liquid tube to the indoor coil.
2. Wrap filter drier with damp cloth.
3. Braze filter drier to above 5-in. (127 mm) liquid tube.
4. Connect and braze liquid refrigerant tube to the filter drier.

CAUTION

UNIT DAMAGE HAZARD

Failure to follow this caution may result in unit damage or improper operation.

Installation of filter drier in liquid line is required.

Filter drier must be wrapped in a heat-sinking material such as a wet cloth while brazing

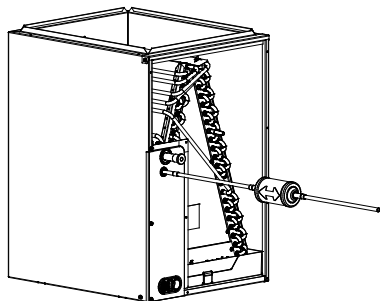

Fig. 5 – Liquid-Line Filter Drier

A05227

Refrigerant Tubing Connection - Outdoor

Connect vapor tube to fitting on outdoor unit vapor service valves (see Table 1).

No Installation of Adapter Tube

Although it is a heat pump this unit has a standard AC liquid service valve. An EXV inside the unit serves as the heating expansion device.

Sweat Connections

CAUTION

UNIT DAMAGE HAZARD

Failure to follow this caution may result in equipment damage or improper operation.

- Use a brazing shield
- Wrap service valves with wet cloth or heat sink material.

WARNING

FIRE HAZARD

Failure to follow this warning could result in personal injury, death and/or property damage.

Refrigerant and oil mixture could ignite and burn as it escapes and contacts brazing torch. Make sure the refrigerant charge is properly removed from both the high and low sides of the system before brazing any component or lines.

CAUTION

BURN HAZARD

Failure to follow this caution may result in personal injury.

Components will be HOT after brazing. Wear appropriate personal protective equipment and allow to cool before handling parts and equipment.

Use refrigerant grade tubing. Service valves are closed from factory and ready for brazing. Clean line set tube ends with emery cloth or steel brush. Remove any grit or debris.

Insert line set tube ends into service valve tube stubs.

Apply heat absorbing paste or heat sink product between service valve and joint. Wrap service valves with a heat sinking material such as a wet cloth.

Braze joints using a Sil-Fos or Phos-copper alloy. Consult local code requirements. Refrigerant tubing and indoor coil are now ready for leak testing. This check should include all field and factory joints.

Pressure Test Tubing and Indoor Coil

Refrigerant tubes and indoor coil should be pressure tested with an inert gas such as nitrogen. Pressurize the system with the inert gas to the Low Side Test Pressure listed on the outdoor unit rating plate

WARNING

EXPLOSION HAZARD

Failure to follow this warning could result in equipment damage or improper operation

Never exceed the test pressures listed on the rating plate when pressure testing an outdoor unit.



Evacuate Refrigerant Tubing and Indoor Coil

! CAUTION

UNIT DAMAGE HAZARD

Failure to follow this caution may result in equipment damage or improper operation.
Never use the system compressor as a vacuum pump.

Refrigerant tubes and indoor coil should be evacuated using the recommended deep vacuum method of 500 microns. The alternate triple evacuation method may be used. See Service Manual for triple evacuation method. Always break a vacuum with dry an inert gas prior to opening the refrigerant system for servicing.

Deep Vacuum Method

The deep vacuum method requires a vacuum pump capable of pulling a vacuum of 500 microns and a vacuum gauge capable of accurately measuring this vacuum depth. The deep vacuum method is the most positive way of assuring a system is free of air and liquid water. (See Fig. 6)

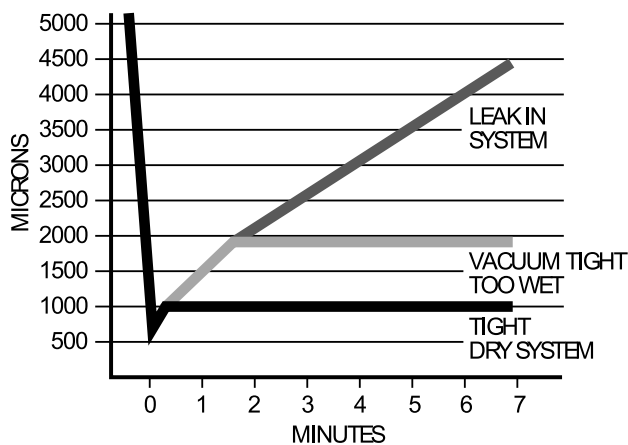

Fig. 6 – Deep Vacuum Graph

A95424

Mandatory Requirements

Pressure Proof Check

Refrigerant tubes and indoor coil should be pressure tested with an inert gas such as nitrogen. Pressurize the system with the inert gas to the Low Side Test Pressure listed on the outdoor unit rating plate

1. Perform a pressure check of the unit with an inert gas charge of about 200 psi, not to exceed the Low Side Test Pressure.
2. The holding charge must NOT decrease in pressure for 1 hour, as indicated by the test gauge. The measuring test gauge resolution not exceeding 5% of the holding charge.

Leak Check

The deep vacuum method requires a vacuum pump capable of pulling a vacuum of 500 microns and a vacuum gauge capable of accurately measuring this vacuum depth. The deep vacuum method is the most positive way of assuring a system is free of air and liquid water. A tight dry system will hold a vacuum of 1000 microns after approximately 7 minutes (See Fig. 6).

! WARNING

FIRE HAZARD

Failure to following this warning could result in personal injury, death and/or property damage.
DO NOT USE FLAMES OR IGNITION SOURCES TO LEAK CHECK.
Vacuum unit to 500 microns. When isolating the unit from the pump, the pressure shall not rise above 1500 microns in 10 minutes.

Final Tubing Check

IMPORTANT: Check to be certain factory tubing on both indoor and outdoor unit has not shifted during shipment. Ensure tubes are not rubbing against each other or any sheet metal. Pay close attention to feeder tubes, making sure wire ties on feeder tubes are secure and tight.

Step 7 – Make Electrical Connections

Be sure field wiring complies with local and national fire, safety, and electrical codes, and voltage to system is within limits shown on unit rating plate. Contact local power company for correction of improper voltage. See unit rating plate for recommended circuit protection device.

NOTE: Operation of unit on improper line voltage constitutes abuse and could affect unit reliability. See unit rating plate. Do not install unit in system where voltage may fluctuate above or below permissible limits.

NOTE: Use copper wire only between disconnect switch and unit.

NOTE: Install branch circuit disconnect of adequate size per NEC to handle unit starting current. Locate disconnect within sight from and readily accessible from unit, per Section 440-14 of NEC.

Route Ground and Power Wires

Remove access panel to gain access to unit wiring. Extend wires from disconnect through power wiring hole provided and into unit control box.

! WARNING

ELECTRICAL SHOCK HAZARD

Failure to follow this warning could result in personal injury or death.
The unit cabinet must have an uninterrupted or unbroken ground to minimize personal injury if an electrical fault should occur. The ground may consist of electrical wire or metal conduit when installed in accordance with existing electrical codes.

Connect Ground and Power Wires

This appliance incorporates an earth connection for safety purposes only. Connect ground wire to ground connection in control box for safety. Connect power wiring to contactor as shown in Fig. 7.

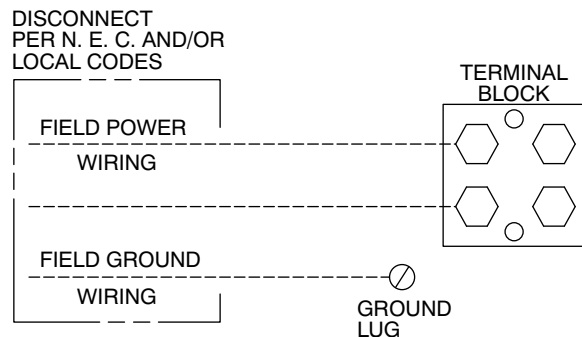

Fig. 7 – Line Power Connections

A14028

Connect Control Wiring

This appliance incorporates an earth connection for safety purposes only. Connect to Infinity® connections. Only two wires (AB) to Infinity® capable indoor unit (furnace or fan coil) is required. Typical 4 wire (ABCD) may be connected (see Fig. 4). C connection is not required but may be beneficial in certain installations that are experiencing communications issues.

IMPORTANT: This system requires the outdoor unit and the indoor unit to have power supplied in order for the Infinity® System Control to communicate with the outdoor unit.

General Information

Use No. 18 AWG or larger color-coded, insulated (35°C minimum) wire for low voltage control wires.

All wiring must be NEC Class 2 and must be separated from incoming power leads.

Use furnace transformer, fan coil transformer, or accessory transformer for control power requirement of system accessories external to the OD unit. The outdoor unit has its own transformer power.

Installations using greater than 200 feet of low voltage wiring should consult the Infinity® System Control manual for additional guidelines regarding daisy chaining wiring method and terminating resistors. Never route control wiring in parallel to high voltage power wires when possible as electrical noise may transfer and generate nuisance fault codes. Where low voltage control and high voltage wires must cross paths, do so at perpendicular angles to eliminate transferred noise.

If further communication issues exist, consider using shielded low voltage wires and only connect shielding to C terminal at end nearest indoor coil.

Final Wiring Check

IMPORTANT: Check factory wiring and field wire connections to ensure terminations are secured properly. Check wire routing to ensure wires are not in contact with tubing, sheet metal, etc.

Step 8 – Compressor Stator Heat

This unit has an internal stator heating function that will be energized during the off cycle. Furnish power to the unit a minimum of 24 hours before starting the unit for the first time.

The internal stator heating function is intelligently demanded by the system to prevent the compressor from being the coldest part of the system and, thus, enhancing the reliability. The stator heat will function as needed any time the outdoor unit is powered. The indoor unit and Infinity® System Control do not need to be installed for the stator heat to operate properly.

Step 9 – Install Accessories

There are no refrigeration circuit or electrical accessories required or available for installation within the unit. External to the unit, the same accessories such as the support feet, snow rack, wind baffle etc., are available on other Carrier units can also be used on this line of product. Refer to the individual Installation Instructions packaged with kits or accessories when installing.

WARNING

PERSONAL INJURY AND/OR PROPERTY DAMAGE HAZARD

Failure to follow this warning could result in personal injury and/or property damage.

For continued performance, reliability, and safety, the only approved accessories and replacement parts are those specified by the equipment manufacturer. The use of non-manufacturer approved parts and accessories could invalidate the equipment limited warranty and result in fire risk, equipment malfunction, and failure.

Please review the manufacturer's literature and replacement parts catalogs available from your equipment supplier.

Step 10 – Start-Up & Charging

CAUTION

UNIT OPERATION AND SAFETY HAZARD

Failure to follow this caution may result in minor personal injury, equipment damage or improper operation.

Observe the following:

1. Do not overcharge system with refrigerant.
2. Do not operate unit in a vacuum or at negative pressure.
3. Do not disable low pressure transducer or system safety devices such as discharge line thermistor or the high pressure switch.
4. Dome temperatures may be hot.
5. Discharge line thermistor is engaged tight on the discharge tube.

CAUTION

PERSONAL INJURY HAZARD

Failure to follow this caution may result in personal injury. Wear safety glasses, protective clothing, and gloves when handling refrigerant and observe the following:

- Service valves are equipped with Schrader valves.

CAUTION

ENVIRONMENTAL HAZARD

Failure to follow this caution may result in environmental damage. Federal regulations require that you do not vent refrigerant to the atmosphere. Recover during system repair or final unit disposal.

WARNING

PERSONAL INJURY HAZARD

Failure to follow this warning could result in personal injury or death. Do not use power tools to open and close service valves. Power tools can cause valve stem to suddenly be ejected from the valve body followed by a high pressure refrigerant leak.

Factory charge amount and desired subcooling are shown in the Infinity® System Control. To properly check or adjust charge, conditions must be favorable for subcooling charging in cooling mode. Favorable conditions exist when the outdoor temperature is between 65°F (18°C) and 105°F (40.6°C) and the indoor temperature is between 65°F (18°C) and 80°F (26.7°C). If the temperatures are outside of these ranges, weigh in charge only. When the temperatures are in the desired range, you may return to the installation site and verify the subcooling to confirm system charge level..

Unit is factory charged for 15ft (4.57 m) of lineset and for smallest internal volume AHRI-rated indoor coil combinations. If any refrigerant charge adjustment is required based on the selected indoor coil combination, lineset dimensions, environment, and outdoor unit coil material, the Infinity® System Control will calculate and display the target subcooling and the amount of additional charge to be added. Therefore the Infinity® System Control is the source of information for charging the system correctly and is critical to accurately input system configuration parameters to ensure proper system operation. Perform a final charge check only when in cooling and OD is between 65°F (18°C) and 105°F (40.6°C).

Table 2 can be used as a guideline for determining which environment to select during system configuration setup.

Table 2 – Environment Type Guideline

Average Annual Relative Humidity (%)	Type
<45	Arid
45 - 65	Semi-Arid
65+	Humid

NOTE: Infinity® System Control indicates acceptable conditions for subcool charging mode. Do not use subcooling charge method if outside 65°F (18°C) and 105°F(40.6°C) outdoor temperature. Subcool charging mode will not be available if conditions are not acceptable.

Nominal subcooling targets are found in [Table 3](#) for use as reference or in specific applications with 25 ft. (7.6 m) lineset, 95°F outdoor ambient, and 80°F/67°F indoor DB/WB.

Table 3 – Standard Subcooling Values

Model Number	Subcooling Value
27VNA024	14
27VNA036	12
27VNA048	5
27VNA060	7

Setup for Infinity® Control Furnace or FE Fan Coil (communicating)

This system can only be installed with Infinity®-capable indoor and Infinity® System Control using the latest software version. When using an Infinity® Control, airflow is automatically selected based on equipment size. The user has the option of selecting Comfort, Efficiency and Max airflow for Heating and/or Cooling modes. These should be selected based on balance between the home owner's comfort and energy consumption expectations. Efficiency airflow is used to meet published AHRI performance ratings. See Infinity® System Control Installation Instructions for additional available adjustments.

Due to using a communicating control with the fan coil or the furnace, dip switch adjustments are not necessary. The outdoor unit configuration and the indoor airflows are determined by communicating control setup. Verify that the PCM, VFD and Infinity® System Control are the latest software before proceeding with the next steps.

Follow these steps to properly start up the system

1. After system is evacuated, close the disconnects to energize indoor unit, outdoor unit, and Infinity® System Control. Do not attempt to operate the system in heating or cooling mode at this time. Mode: OFF. Vapor and liquid line service valves should be fully closed.
2. If the outdoor ambient temperature is between 65°F and 105°F and the indoor temperature is between 65°F and 80°F then the system may be charged using the subcooling method. At this time fully open the liquid and vapor service valves if the subcooling method is to be used.
3. The Infinity® System Control will proceed through a series of setup screens. Follow these setup screens to correctly configure the indoor unit, lineset configuration, climate zone, and outdoor unit coil material ([Fig. 8](#)). Selecting a line in the system configuration screen will take the user to the respective selection screen for the line item ([Fig. 9](#) and [Fig. 10](#)). “Press to select” in red letters indicates the line must be pressed and the odu material type chosen before learning can continue.

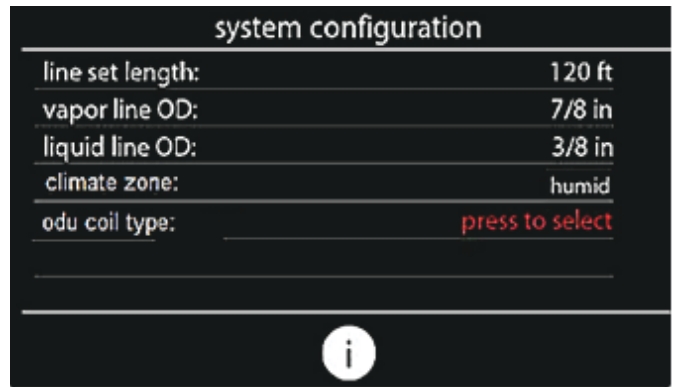

Fig. 8 – System Configuration Screen

A240369

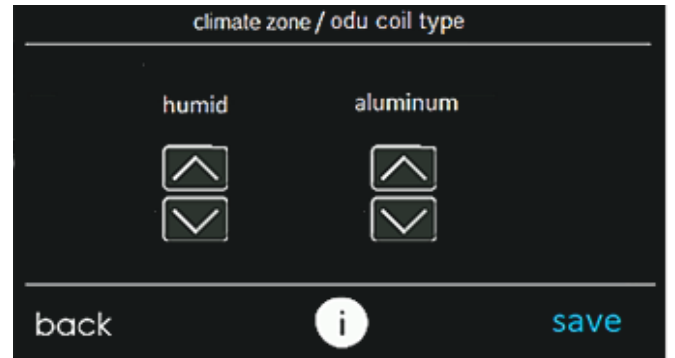

Fig. 9 – Select Environment and Material

A240351

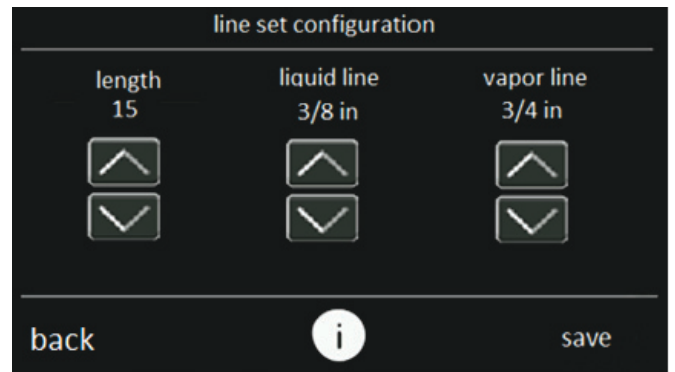

Fig. 10 – Select Lineset

A240350

4. The Infinity® System Control will then advance through the remaining learning processes including the setup of accessories such as filter type, UV light, and humidifier. Upon completion of the setup screens, the equipment summary screen will be presented ([Fig. 11](#)). Verify the correct equipment is shown on this screen. Next an airflow verification test is executed before returning to the main screen.
5. Navigate to the “Installation and Service menu” by performing a long press on the service icon from the main screen (see [Fig. 12](#)). Once in the “Installation and Service” menu, select “Refrigerant Charging” (see [Fig. 13](#)).

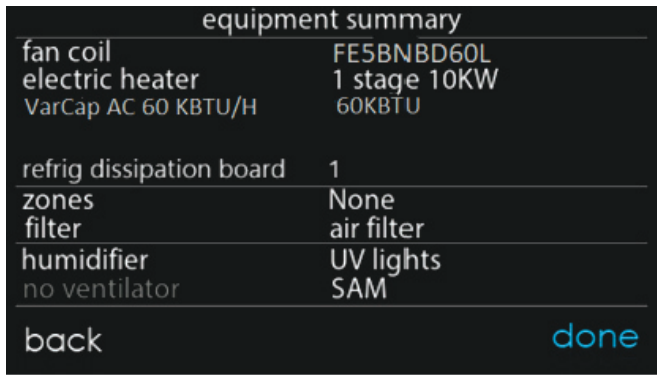

Fig. 11 – Equipment Summary Screen

A240344

NOTE: A leak dissipation board must be present for the Infinity® System Control to allow unit operation.



Fig. 12 – Entering Installation and Service Menu

A200029

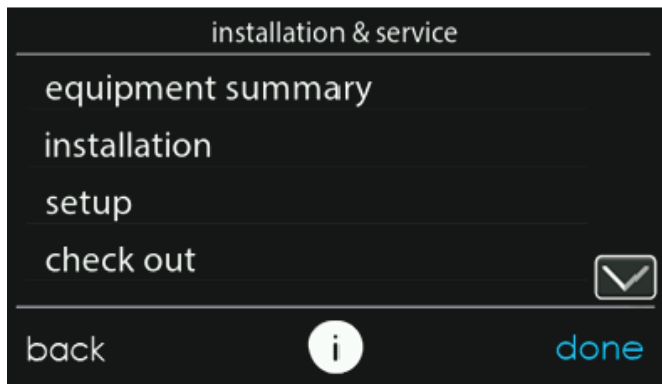
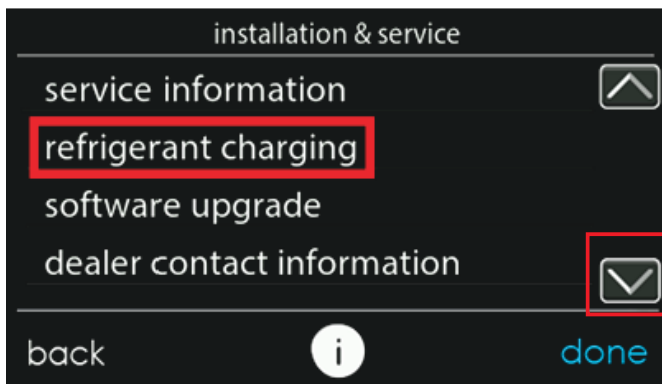

Fig. 13 – Installation and Service Menu

A200030

During initial installation, the system mode should be OFF. When system mode is OFF, all menu selections are available. When system mode is either in Cooling or Heating, only "check charge - cooling / heating" is available for selection.

- For new installations, select "new ODU (factory pre-charged)" from the refrigerant charge screen to begin charging the system (Fig. 14). For applications where there is no charge in the ODU, select "full system charge/recharge".

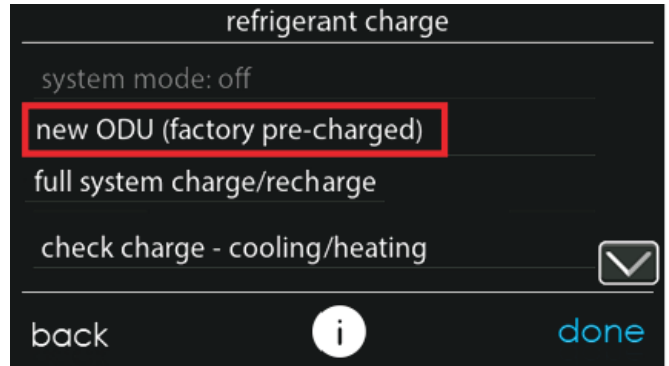

Fig. 14 – Refrigerant Charge Mode Selection

A240370

- If indoor and outdoor conditions are in range, subcooling status will be green and available (Fig. 15). If conditions are outside the range, subcooling status will be red and unavailable and will require a partial weigh-in of charge (Fig. 16). Both "new ODU (factory pre-charged)" and "full system charge/recharge" modes will allow the user to move forward to start the system regardless of whether subcooling charging is available. Lineset configuration and climate zone / odu material type can be changed by selecting appropriate line if needed. For "new ODU (factory pre-charged)" record the ADDITIONAL charge amount listed. For "full system charge/recharge", record the FULL system charge amount listed. Press continue.

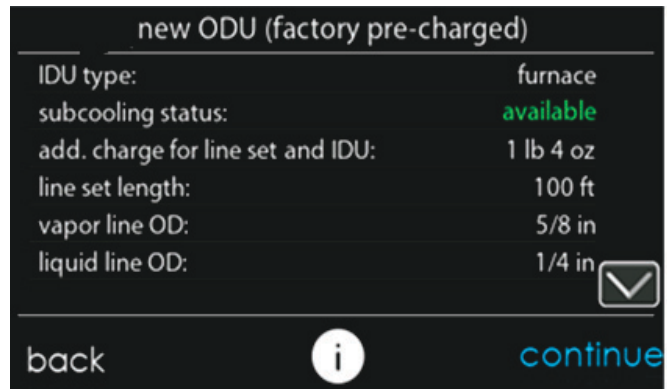

Fig. 15 – New ODU (factory pre-charged) - Subcooling Available

A240371

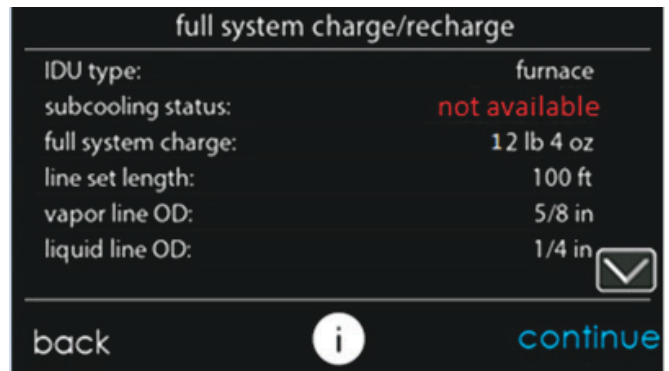

Fig. 16 – Full System Charge/Recharge - Subcooling Unavailable

A240372

- The next screen, “cooling charge mode start” is shown in Fig. 17 or Fig. 18 depending on whether subcooling charging is available. The reason for unavailability of subcooling can be viewed by pressing the down arrow to go to the second page. Before selecting “Start”, verify that the service valves are open. Pressing start will turn on the system at a fixed set of operating parameters in COOLING mode.

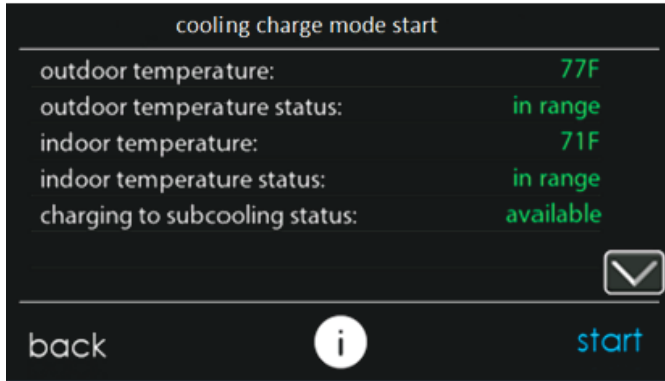

Fig. 17 – Cooling Charge Mode Start Screen - Subcooling Available ^{A240373}

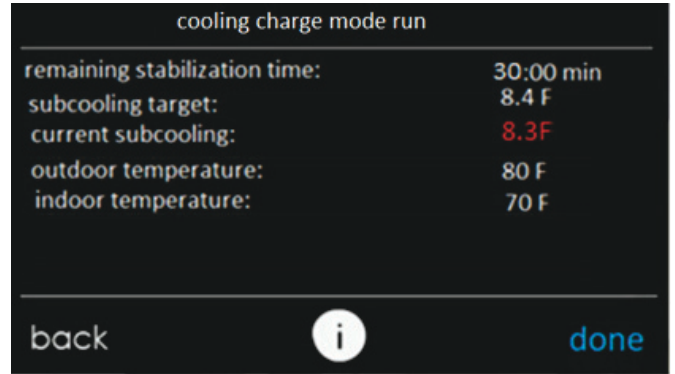

Fig. 19 – Cooling Charge Mode Run Screen ^{A240375}

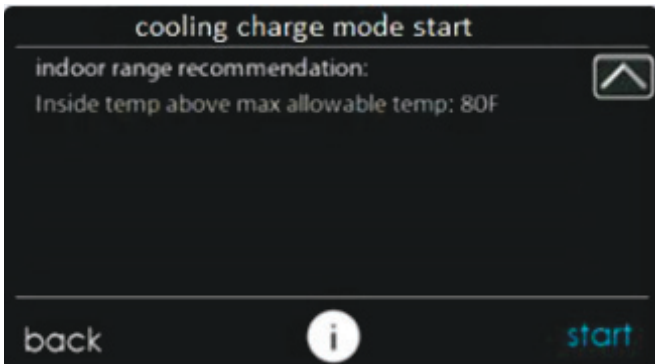
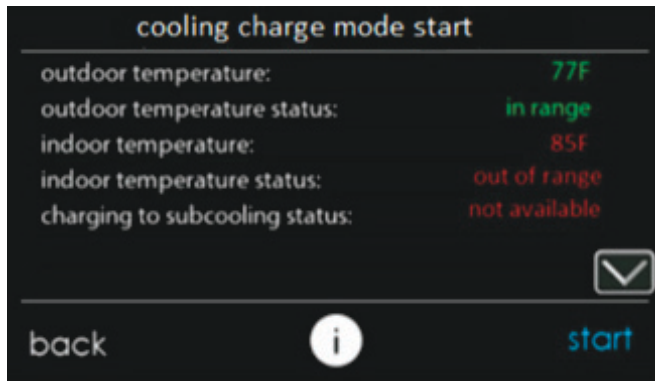

Fig. 18 – Cooling Charge Mode Start Screen - Subcooling Unavailable ^{A240385}

- Once start has been pressed, the next screen will show the target subcooling that should be attained while charging. If subcooling mode is not available, the current subcooling and target will display as dashes and the refrigerant must be weighed in. Weigh in the charge amount recorded in Step 7. The charge level may then be checked at another time when both the indoor and outdoor temperatures are in a more favorable range that allow for subcooling charging.

When subcooling is available, the current subcooling will appear in red (Fig. 19) until the stabilization timer is 0 where it will then turn green, indicating the system has stabilized. "Current subcooling" is calculated using sensors inside the ODU, but may be in error until stabilization time has completed. Compare the "current subcooling" to the “subcooling target” listed on the charging screen. Add refrigerant if the subcooling is low and remove refrigerant if

subcooling is high. Tolerance should be $\pm 1^\circ\text{F}$. It is recommended to validate the subcooling using traditional methods of measuring temperature and pressure at the liquid service valve when charging the system. Refer to Table 4 for guidance on required liquid line temperature for a given subcooling and liquid service valve pressure.

Table 4 – Required Liquid Line Temperature for R-454B

Liquid (PSIG) Pressure at Service Valve	R-454B Subcooling Temperature (F)					
	6	8	10	12	14	16
238	78	76	74	72	70	68
245	80	78	76	74	72	70
252	82	80	78	76	74	72
260	84	82	80	78	76	74
268	86	84	82	80	78	76
276	88	86	84	82	80	78
284	90	88	86	84	82	80
292	92	90	88	86	84	82
301	94	92	90	88	86	84
309	96	94	92	90	88	86
318	98	96	94	92	90	88
327	100	98	96	94	92	90
336	102	100	98	96	94	92
346	104	102	100	98	96	94
355	106	104	102	100	98	96
365	108	106	104	102	100	98
375	110	108	106	104	102	100
385	112	110	108	106	104	102
396	114	112	110	108	106	104
406	116	114	112	110	108	106
417	118	116	114	112	110	108
428	120	118	116	114	112	110
439	122	120	118	116	114	112
450	124	122	120	118	116	114

- If any adjustment is necessary, add or remove the charge slowly (no greater than 0.5 lb per minute) and allow system to operate for at least 15 minutes to stabilize before declaring a properly charged system. The use of a commercial charge metering device (restrictor) such as Imperial liquid low side charger model 535-C or Watsco ChargeFaster model CH200 is recommended when adding refrigerant to an operating system. This prevents potential damage of liquid slugging of the compressor and allows the subcooling to stabilize quicker.
- If the lineset is less than 15 ft. (4.57 m) in length, charge removal may be necessary and will be shown as a negative number on Infinity® System Control screen. Note that the Infinity® System Control screen displays charge in lb and oz, while unit rating plate is in decimal format.

Check Charge - Cooling / Heating

The check charge workflow allows a user to operate the system at fixed, charge mode operating parameters. In either heating or cooling modes cooling, this can be used to evaluate subcooling using the sensors on the unit. Before adjusting charge, it is recommended to verify subcooling measurements at the liquid service valve. In heating, this mode can be paired with the Heating Check Chart, located on the inside of the control box cover of the ODU, to evaluate if a system is significantly over or under charged by measuring suction and discharge pressures and superheat measured at the vapor service valve. DO NOT adjust charge using the Heating Check Chart. If system is suspected to be incorrectly charged, recover refrigerant according to the Service Manual and recharge using the "full system charge/recharge" method.

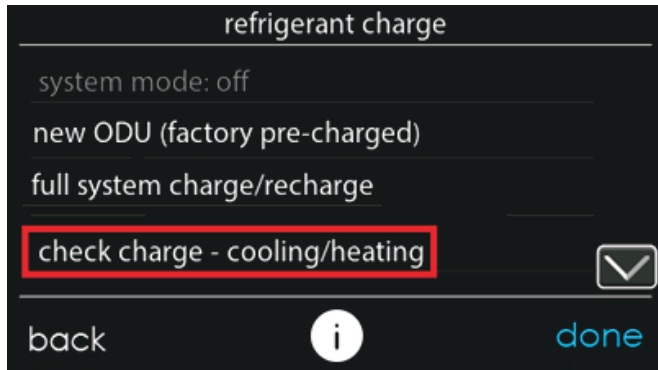

Fig. 20 – Selecting Charge Mode

A240376

When indoor and outdoor conditions are in range, "clg check charge" status will be green and available. If conditions are outside the range, "clg check charge" will still be available unless dissipation fault is active or outdoor ambient temperature is too low. Additionally, a note will be displayed below the status indicating the reason for why a given mode is not available.

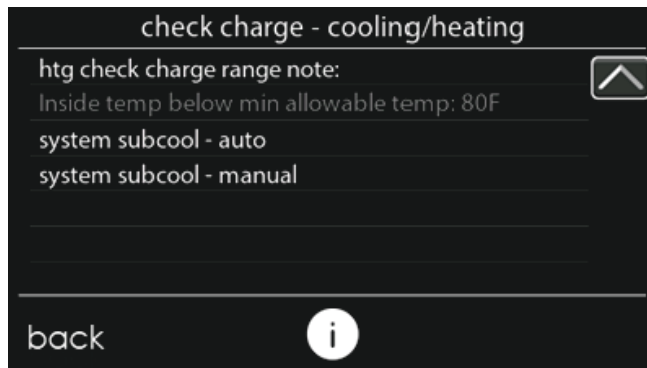
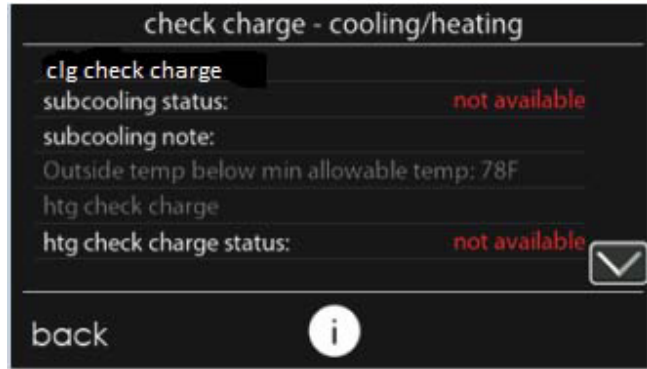
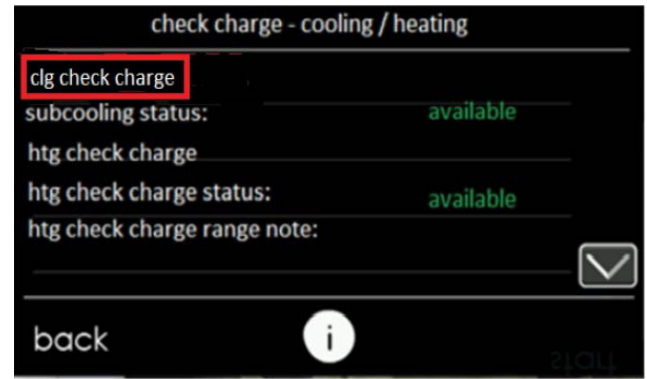

Fig. 21 – Cooling Charge Mode

A240377

Pressing "clg check charge" in Fig. 21 will take the user to the "cooling charge mode start" screen that is outlined above in steps 8-11. Follow these steps to complete charge verification. Only use "clg check charge" mode to adjust charge when subcooling is available.

Pressing the "htg check charge" will take the user to the Heating Check Charge screen (see Fig. 22 - Fig. 23) After pressing start, observe operation and compare the system pressures and temperatures to those on the Heating Check Chart located on the inside of the control box cover of the ODU. If system is suspected to be incorrectly charged, recover refrigerant according to the Service Manual and recharge using the "full system charge/recharge" method. DO NOT adjust charge using the Heating Check Chart.

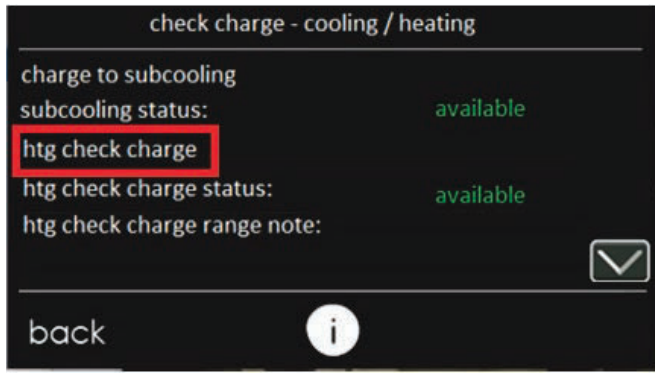

Fig. 22 – Heating Check Charge

A240380

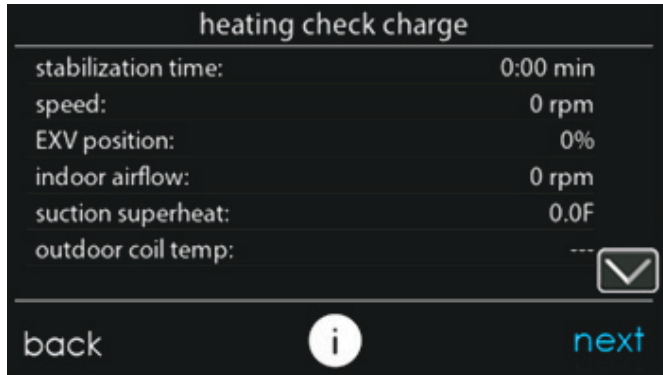

Fig. 23 – Heating Check Charge Screen 1

A240382

Post Charging

Final charge should be recorded on the outdoor unit charging label with permanent and legible writing. Total refrigerant charge is factory charge plus any added charge. Verify the indoor space served by the indoor unit, including spaces connected by ductwork, exceeds the minimum room size as listed on the outdoor unit charging label. Refer to Table 5

Table 5 – Minimum Room Area Charging Table

Total System Charge (lbs.)	Minimum Floor Area ft. ² (m ²)
4	61 (5.7)
5	76 (7.0)
6	91 (8.5)
7	106 (9.8)
8	122 (11.3)
9	137 (12.7)
10	152 (14.1)
11	167 (15.5)
12	182 (16.9)
13	198 (18.4)
14	213 (19.8)
15	228 (21.2)
16	243 (22.6)
17	258 (24.0)
18	274 (25.5)
19	289 (26.8)
20	304 (28.2)
21	319 (29.6)
22	335 (31.1)
23	350 (32.5)
24	365 (33.9)
25	380 (35.3)

Step 11 – Pump Down & Evacuation

Because this system has a VFD controlled compressor the conventional procedure cannot be used to "pump down" and isolate the refrigerant into the outdoor unit. The Infinity® System Control has provisions to assist in performing this function.

1. Connect gauges to liquid and vapor or suction capillary service ports to monitor operating pressures during and at completion of the procedure.
2. In the "installation and service" menu of the Infinity® System Control (see Fig. 12), go to "refrigerant charging" and then "pump down" (see Fig. 13 and Fig. 24).
3. Pump down in COOL mode allows refrigerant to be isolated in outdoor unit. Set desired time period. Default time period for the procedure is 20 minutes. See Fig. 25.
4. Select Start on Infinity® System Control to begin the pump down process. Unit will begin running in cooling mode after a brief delay and a status screen will be displayed. See Fig. 26.
5. Close the liquid service valve.
6. The unit will run with the low pressure protection set to indicate pump down is complete when the suction pressure drops below 20 psig. Compressor protections are still active to prevent damage to the compressor or VFD (high pressure, high current, etc.).
7. Once system indicates pump down complete or failure to complete shutdown, close vapor service valve.
8. A recovery system will be required to remove final quantity of refrigerant from indoor coil and line set. Refer to Service Manual for specific evacuation and purge steps required after recovering refrigerant and before making any repairs to the indoor unit or lineset.
9. Remove power from indoor and outdoor unit prior to servicing unit.

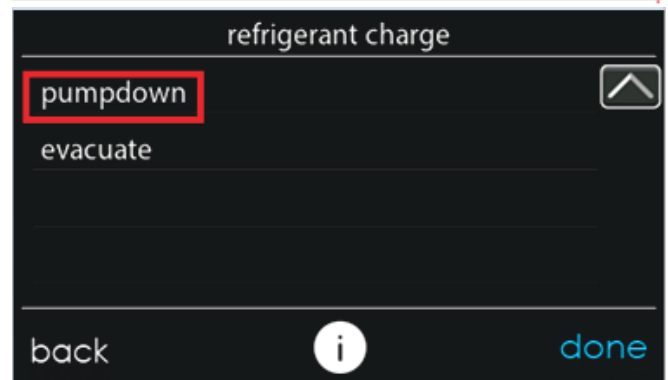
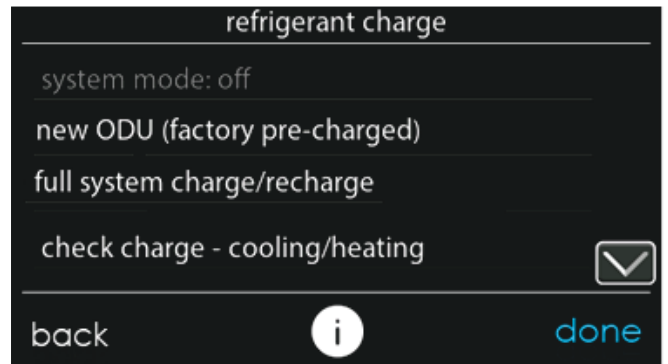

Fig. 24 – Pump Down and Evacuation Selection

A240378

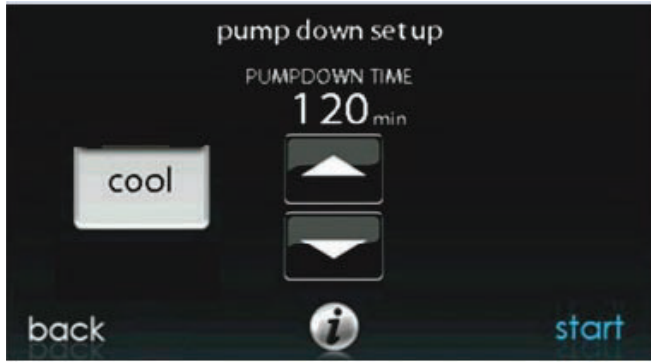

Fig. 25 – Pump Down Setup Screen

A240390

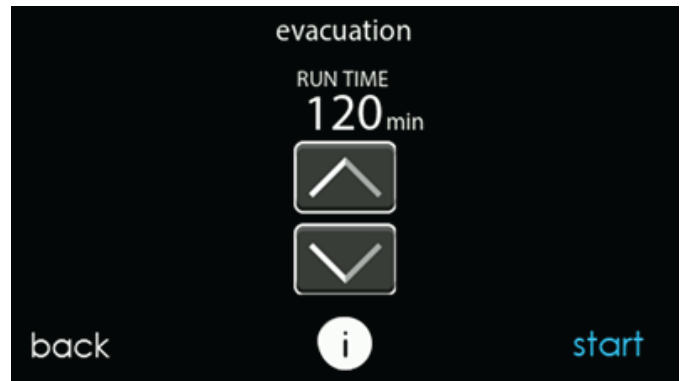

Fig. 27 – Evacuation Setup Screen

A20042



Fig. 26 – Pump Down Active Screen

A240342

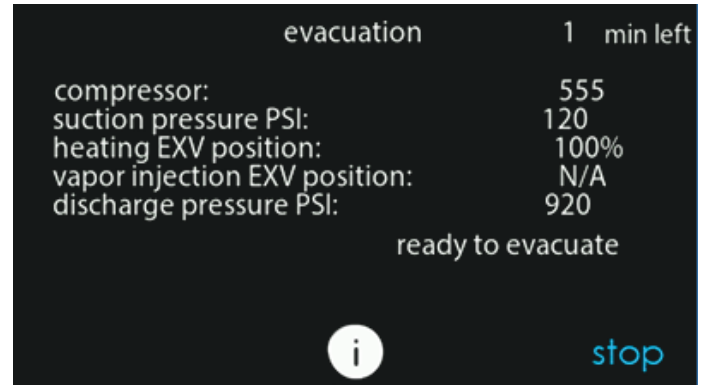

Fig. 28 – Evacuation Status Screen

A20043

Evacuation and Recovery of Refrigerant from within 27VNA0

Because this system has an EXV for the heating expansion device, additional steps must be taken to open the EXV if the heat pump unit must be evacuated for service reasons. If the EXV is not open when pulling a vacuum or recovering refrigerant from the heat pump unit, extended evacuation time may be required and/or inadequate vacuum obtained. The Infinity® System Control has provisions to open the EXV for refrigerant recovery and/or evacuation.

1. Connect gauges to liquid and vapor or suction capillary service ports to monitor operating pressures during and at completion of the procedure. Attach recovery system or vacuum pump to gauge set as needed for the service procedure. The service valves must be open to evacuate the unit through the line set service ports. The suction capillary service port is a direct connection to the suction port of the compressor.
2. In the “installation and service” menu of the Infinity® System Control (see Fig. 12), go to “refrigerant charging” and then “evacuation” (see Fig. 13).
3. Set desired time period. Default time period for the procedure is 20 minutes. See Fig. 27.
4. Select START on Infinity® System Control to open the valve.
5. Begin evacuation or refrigerant recovery as required for the procedure after Infinity® System Control indicates the EXV is open. Power may be removed from heat pump after the Infinity® System Control indicates “READY TO EVACUATE.” See Fig. 28.
6. Remove power from indoor and heat pump unit prior to servicing unit. The EXV will retain the open position.

NOTE: See service training materials for troubleshooting the EXV using EXV CHECK mode.

Step 12 – System Functions and Major Components

The 27VNA0 models utilize a communicating Infinity® System Control. When a demand for cooling or heating exists, the Infinity® System Control will direct the outdoor unit to operate at the minimum required speed to satisfy demand. With a call for cooling or heating, the outdoor fan is first energized, followed shortly by the compressor, where they will both operate at a start speed for a brief period. Once certain start criteria are met, the compressor and fan will ramp to the target demand speeds. If continued operation at the initial speed does not satisfy demand, the system will ramp up in 60 RPM increments until it satisfies the demand. After the higher demand is met, the unit will modulate capacity such that demand is met and indoor conditions are maintained. Ideal performance is achieved when system operates continuously at the lowest speed possible, minimizing variation in conditioned space temperatures while using minimal power.

As the unit operates at lower capacity, system vapor (suction) pressure will be higher than it is during a standard single-stage system operation or during a higher capacity operation.

When all demand is satisfied, the compressor will shut off. An internal pressure equalization valve will energize during the off-cycle to allow for easy start up at the next call for cooling or heating.

The Infinity® System Control displays the operation mode and fault codes as specified in the troubleshooting section. See [Table 11](#) for codes and definitions.

Primary Control Module

The Primary Control Module (PCM) controls the various functions of the outdoor unit. The PCM has the following outputs:

1. Main EXV (EXV-H)
2. VFD Modbus communication (VFD COMMS)
3. VFD low-voltage relay control
4. Reversing Valve (RVS)
5. Pressure Equalization valve (PEV)
6. O signal
7. W signal

The PCM has the following inputs:

1. Outdoor Discharge line Temperature (ODT) Thermistor
2. Outdoor Air Temperature (OAT) Thermistor
3. Outdoor Coil Temperature (OCT-HP) Thermistor
4. Outdoor Suction Temperature (OST) Thermistor
5. Liquid Line Temperature (LLT-HP) Thermistor
6. Discharge & suction pressure transducers (DPT & SPT). Labeled as P1 & P2 on the PCM
7. Service Interface communication port (SERVICE PORT)
8. CCN communication (ABCD plug)
9. Model plug
10. 24VAC input power

The PCM receives a cooling or heating demand from the Infinity® System Control and determines the appropriate compressor, fan, reversing valve and PEV action based upon the various sensor inputs.

Utility Interface With Infinity® Control

The utility curtailment relay should be wired between the two UTIL connections on the control board for this Infinity® Communicating System (see Fig. 29). This input allows a power utility device to interrupt compressor operation during peak load periods. When the utility sends a signal to shut the system down, the Infinity® System Control will display “Curtailment Active”. See Infinity® System Control installation instructions for setup details.

Infinity® Control, Green Communications (COMM) Light

A green LED (COMM light) on the outdoor board (see Fig. 30) indicates successful communication with the other system products. The green LED will remain OFF until communication is established. Once a valid command is received, the green LED will turn ON continuously. If no communication is received within 2 minutes, the LED will be turned OFF until the next valid communication.

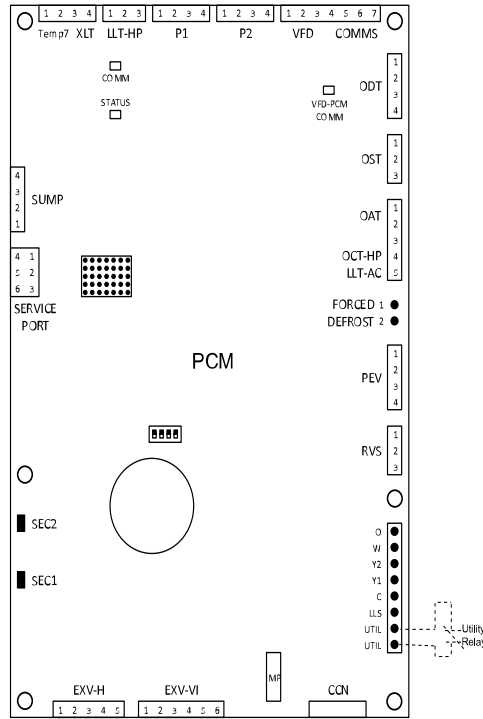

Fig. 29 – Control Board with optional Utility Relay

A230529

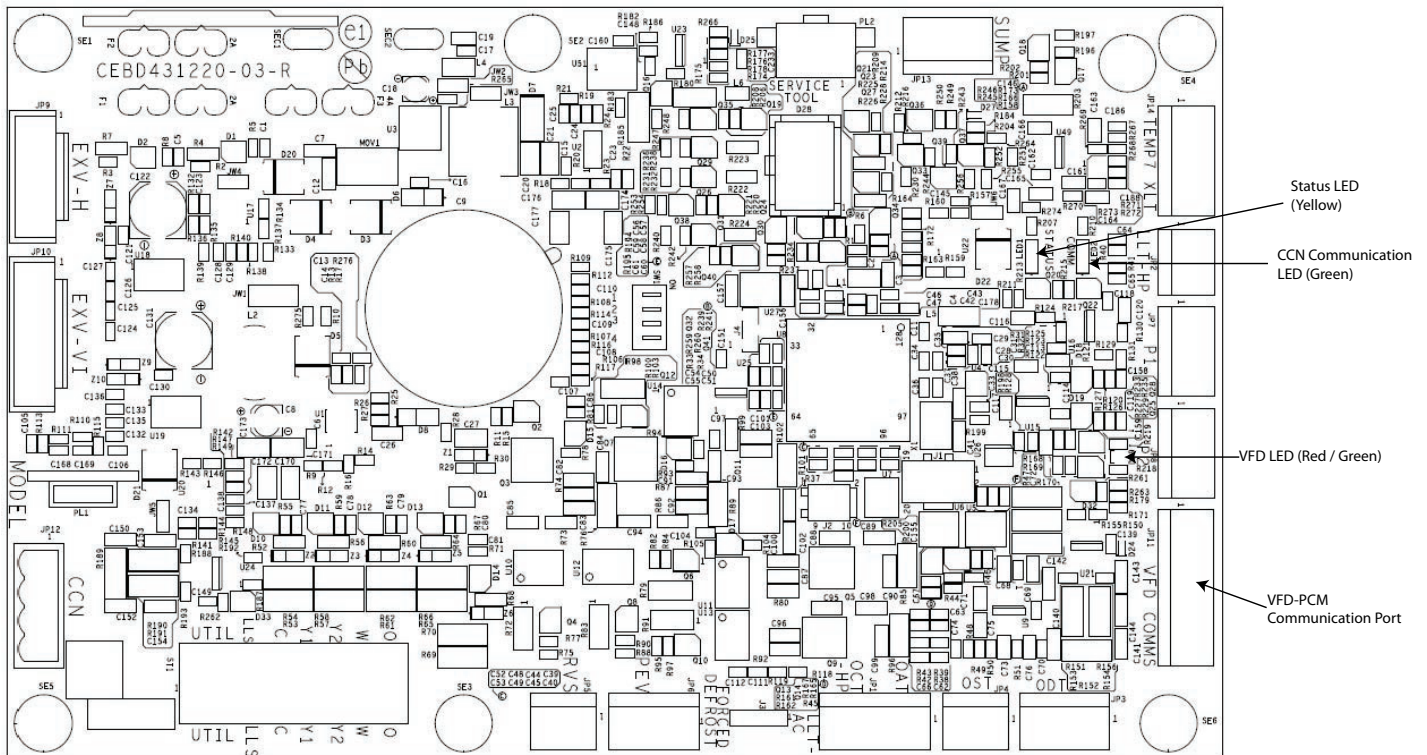

Fig. 30 – Primary Control Board

HK38EA069

Amber Status Light

The operation modes and meaning for each mode of the status light is described in the table below for PCM SW versions 1.0 and above.

Mode	Meaning
Off	Power is removed from the PCM or there is a fundamental PCM fault.
On	Equipment is in standby with no diagnostic conditions preventing or limiting operation.
1 Slow Flash	Equipment is operating at low capacity (low stage in emergency mode).
2 Slow Flashes	Equipment is operating at high capacity (high stage in emergency mode).
Continuous Slow Flash	Equipment operation has been interrupted or is being limited.
Continuous Fast Flash	Equipment is in a lockout condition as a result of a diagnostic condition or is in Diagnostic Code Recall mode.

5x7 LED Matrix

The Primary Control Module (PCM) is equipped with a 5x7 LED matrix. This matrix will display the 4 highest priority diagnostic codes in a scrolling fashion with 2 seconds in between each code. At the end of the 4th highest priority diagnostic code there is a 5 second pause before the list repeats.

VFD Communications Light

The PCM is equipped with a bi-color LED for indicating successful or unsuccessful communication with the VFD. This LED is located just below the VFD-PCM communication port on the PCM. The LED will flash green when good messages are received from the VFD and red when bad or no messages are received from the VFD.

Bluetooth® Module

This unit is equipped with a module, which includes Bluetooth wireless technology that allows a user to connect via an application on a phone or tablet. It is recommended that the Bluetooth Module be activated during the installation process.

Follow these steps to download and activate Bluetooth Module:

1. Download the app
 - Search the App Store™ or Google Play™ for Carrier Service Technician to download. The app is available on phone and tablet devices. If you already have the app downloaded, please ensure you have updated to latest version.

To Activate Bluetooth Module:

1. Login to the Carrier Service Technician app using your HVACPartners user name and password.
2. On the App Home screen, tap the Connect to Equipment button. Please ensure your equipment is powered on and your mobile

device is within 10 feet of the equipment throughout this whole process

NOTE: In order to connect to equipment using Bluetooth, you must have Bluetooth enabled on your mobile device, and you must allow the Service Tech app to access Bluetooth and location services in your device permissions. For more information on how to enable these features and permissions, please consult documentation from your device manufacturer.

3. The app will scan for nearby Bluetooth enabled equipment. To activate a new unit, the app will display “New Equipment”. Tap on that item and then select the Pair button
4. The app will display the equipment Serial and Model number. Please confirm these are correct for the equipment you are trying to activate and tap continue.
5. The app will now automatically progress through the activation process. Once the steps are complete, the unit is activated successfully and your device will be automatically paired to the equipment.

NOTE: You will only have to perform this activation once and you will now be able to pair to this equipment directly with the app in the future.

Variable Frequency Drive (VFD)

The VFD or variable frequency drive is located inside the control box. This is an air-cooled device that communicates with the PCM and drives the compressor to the demanded RPM. The VFD provides DC voltage to the fan motor and sends a fan RPM signal to the electronics on the fan motor. The VFD changes single phase line voltage to a 3-phase output that varies in both voltage and frequency to drive the compressor.

The VFD is equipped with several LEDs that indicate different statuses. see [Table 6](#) and [Fig. 31](#).

Table 6 – VFD LED Indicator Functions

LED Identification	Color	Function
R1	Red	Used to indicate that high voltage is present in the DC capacitors. If this LED is lit then a DC voltage greater than 40V is present.
G1	Green	Blinks when the VFD receives a message from PCM.
G2	Green	On when VFD is in normal status. It is off when VFD is fault status.
G3	Green	On when the VFD micro-controller relay is closed. The signal of relay is controlled by PCM.
A1	Amber	On when 12V source is normal.
A2	Amber	On when the main relay is closed.

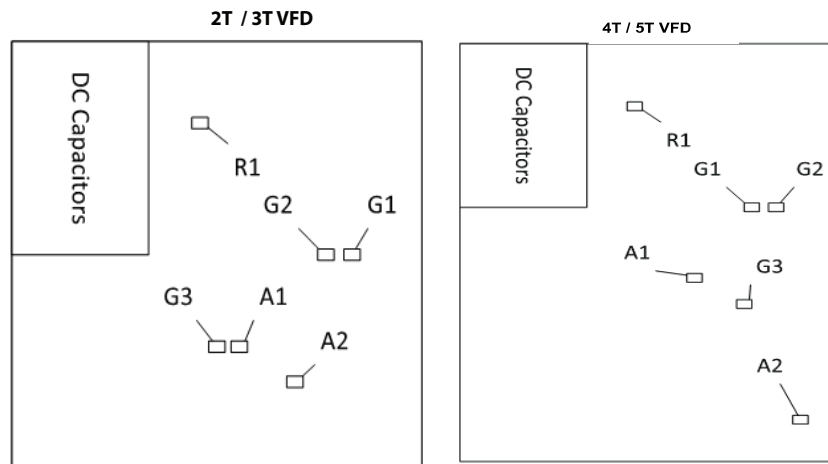

Fig. 31 – VFD LED Indicators

! WARNING

ELECTRICAL HAZARD - HIGH VOLTAGE

Failure to follow this warning could result in personal injury or death. Electrical components may hold charge. **DO NOT** remove control box cover for 2 minutes after power has been removed from unit. **PRIOR TO TOUCHING COMPONENTS:** Verify zero (0) voltage at VFD connections shown on control box cover.

Input Filter Board

The input filter board connects the line voltage to the VFD. The input filter board ensures the inherent electrical noise generated by VFD does not affect other electronics in the household and contains fuses to protect against excess input current.

Reactors

There are either 1 or 2 reactors per system depending on model. These reactors are large inductors and must be connected to the VFD to operate.

Variable Speed Compressor

This unit contains a high-side variable speed compressor that has a wide operating range. These models contain variable speed rotary compressors. All of the variable speed compressors operate on 3PH AC provided by the VFD. This compressor can only be operated by the specific VFD supplied with the unit.

! CAUTION

EQUIPMENT DAMAGE HAZARD

Failure to follow this caution may result in equipment damage. Do not attempt to apply line voltage directly to the compressor. This will destroy the compressor

Time Delays

The unit time delays include:

- Five minute time delay to start cooling or heating operation when there is a call from the Infinity® System Control. To bypass this feature, momentarily short and release Forced Defrost pins.
- Five minute compressor re-cycle delay on return from a brown-out condition.

Heating Electronic Expansion Valve (EXV-H)

This unit uses an electronic expansion valve for refrigerant metering in the heating mode. The control board drives the EXV to its proper position based on the operating mode and conditions.

Variable Speed Fan Motor

The fan motor included in this unit is a Brushless DC motor with an integrated control module. The control module is supplied DC voltage from the VFD. The speed command is provided from the VFD through a 0-5V signal. The commanded speed is determined by the PCM and is communicated through Modbus to the VFD. The motor cannot be connect to line voltage. Fan motor speed varies based on outdoor ambient temperature, compressor, speed, and system demand. The fan motor will not operate during defrost and may cycle off and on if extremely low airflow is requested by the outdoor unit controls.

Pressure Equalization Valve (PEV)

The PEV is located at the discharge of the compressor and the inlet to the accumulator. The purpose of the PEV is to prevent the compressor from starting with a high pressure differential, which can cause compressor damage. Occasionally the unit may experience a brief starting delay while the PEV equalizes pressure before startup.

High Pressure Switch

This unit contains a high pressure switch to protect against high pressure conditions. This switch must be closed for the VFD to be powered.

Outdoor Pressure Transducers

There are two pressure transducers installed on this unit. The pressure transducers are connected to the P1 and P2 inputs on the PCM. Each transducer may be connected to either PCM input. These transducers have a range from 0 to 620 psig and are used for system protection, control, and diagnostics.

Stator Heater Operation

This unit has an internal stator heating function. The compressor windings will occasionally be energized during the OFF cycle to start the stator heat operation, thus maintaining a sump temperature that is essential for compressor reliability. The compressor will not run during this process.

Infinity® Controlled Low Ambient Cooling

This unit is capable of low ambient cooling down to 0°F (-17.8°C) with Low Ambient enabled on the Infinity® System Control. A low ambient kit is not required.

The Infinity® System Control provides an automatic evaporator coil freeze-protection algorithm that eliminates the need for an evaporator freeze thermostat. The only accessories that may be required are wind baffles in locations likely to experience cross winds in excess of 5 miles an hour. This generally occurs only on roof and open-area applications.

Low ambient cooling must be enabled in the Infinity® System Control setup. The outdoor unit fan will cycle on and off based on outdoor coil temperature, outdoor air temperature, and suction pressure measurements to keep the compressor running at the proper conditions.

Defrost

The Infinity® System Control offers 4 possible defrost interval times: 30, 60, 90 minutes or AUTO. The default is AUTO.

Defrost interval times: 30, 60, 90 minutes or AUTO are selected by the Infinity® System Control (dip switches are not used.)

Auto mode will adjust the defrost interval dynamically based on real-time frost accumulation and provide optimum system performance when a fixed defrost interval time is chosen. In Auto mode, defrost will begin when frost is detected on the coil. In non-frosting conditions, it is possible to the unit to run for several days without initiating defrost..

The defrost process begins when the defrost interval time is reached under frost-accumulating conditions. The defrost process ends when the coil has sufficiently thawed and been allowed time to drain. Defrost may also terminate as a result of a time limit - usually 15 minutes. If Defrost is forced via the Forced Defrost input, defrost will be initiated regardless of frost accumulation time or outdoor temperature. A forced defrost will run at least 30 seconds, but may not run longer than 30 seconds if ambient temperature is well above freezing.

NOTE: Compressor speed during defrost varies based on outdoor conditions and unit model

Troubleshooting

Systems Communication Failure

If communication with the Infinity® System Control is lost, the control will flash the appropriate fault code (see [Table 11](#)). Check the wiring to the Infinity® System Control and the indoor and outdoor units and power.

Model Plug

The system PCM has been pre-programmed with an electronic model plug that establishes the model configuration, i.e. size and type, of the unit. This electronic model plug removes the need for a physical model plug to be installed into the PCM. A set of physical model plugs for all sizes is available as a service component for use when replacing the PCM and/or the model configuration is missing or unknown. Additionally, the model configuration can be set using the Infinity® System Control, the Service Tech App, or the PCM dip switches. The correct model configuration must be set for the system to operate properly. (see [Table 7](#)). Refer to the Service Manual for more information on model configurations.

Table 7 – Model Plug Information

MODEL NUMBER	MODEL PLUG NUMBER	PIN RESISTANCE (K-ohms)		PCM Model
		Pins 1-4	Pins 2-3	HP
27VNA024	HK70EZ003	5.1K	24K	24K-HP
27VNA036	HK70EZ015	5.1K	360K	36K-HP
27VNA048	HK70EZ027	11K	150K	48K-HP
27VNA060	HK70EZ039	18K	62K	60K-HP



CAUTION

EQUIPMENT DAMAGE HAZARD

Failure to follow this caution may result in equipment damage and/or improper operation.

Do not attempt to install an incorrect model plug as this could cause some units to operate incorrectly and fail prematurely.

NOTE: Model configuration diagnostics will occur while the equipment is operating, but changes to a model configuration using a physical model plug will not affect equipment operation until power is cycled. An electronically set model configuration will take effect immediately. The PCM remembers the most recent valid model configuration detected at power-up, regardless of that configuration coming from an electronic or physical model plug. Model configuration memory is preserved across power cycles, so proper equipment operation will continue even if power to the equipment is lost and then restored. An installed model plug at power-up takes precedence over a model configuration value stored in memory. If a new valid model plug value is detected at power-up, the model configuration memory will be updated to that new value.

Pressure Switch Protection

The outdoor unit is equipped with high pressure switch. If this switch opens the VFD will lose line power and the compressor and fan motor will not operate. The high pressure switch opens at 670 +/- 10 psig and closes at 470 +/- 25 psig. If this occurs the PCM will set a diagnostic code per [Table 11](#). The outdoor pressure transducer installed at the discharge of the compressor is monitored by the PCM and the PCM will take action to avoid the high pressure switch from opening.

Compressor Protection

The Primary Control Module continuously monitors the operation of the compressor and takes action when it is nearing the edge of the boundaries of reliable operation. The PCM utilizes the pressure transducers to maximize the reliability and minimize the off time of the system due to operation outside of the compressor boundaries. The PCM takes different actions for each edge of the boundary, but each culminates in a reduction of compressor speed to the minimum allowable and, in the worst case, will power off the compressor to avoid excursions outside the boundaries. If a shutdown does occur then the PCM will set a diagnostic code per [Table 11](#).

Line Voltage Diagnostics

The primary control module monitors the line voltage for low and high voltage events. If a low voltage or high voltage event occurs and another fault occurs simultaneously the PCM will set a fault that indicates this was due to the system conditions and not the components. If this occurs several times in a row the PCM will set a malfunction and lock out operation for 1-4 hours, depending on the condition. Refer to [Table 11](#) for the list of fault codes and [Table 12](#) for the list of malfunctions and the lockout times for each one.

Forced Defrost Pins

The forced defrost pins have several functions. When shorting the pins using a clip wire the below functions can be executed:

If the pins are shorted for more than 5 seconds and the unit is in heating mode, the unit will enter into a defrost.

If the pins are shorted more than 1 second and less than 5 seconds when the system has just turned off and an active call for cooling or heating is present, the 5 minute initial on-time will be defeated.

If the unit is in the OFF mode and the pins are shorted at power on the unit will enter into Status Code Recall Mode.

Temperature Thermistors

Thermistors are used to sense the outdoor ambient (OAT), outdoor coil (OCT-HP), liquid line (LLT-HP), any outdoor discharge (ODT) line temperatures. All thermistors are 10K thermistors except for the ODT, which is a 50k thermistor.

Refer to [Table 8](#) and [Table 9](#) for resistance values versus temperature for the OAT, OCT - HP, ODT, and LLT - HP.

Table 8 – 10K Thermistor Resistance Values

TEMPERATURE	RESISTANCE (K OHMS)
25.0°C (77.0°F)	10.0 +/- 2.3%
0.0°C (32.0°F)	32.6 +/- 3.2%
-17.8°C (0 °F)	85.5 +/- 3.4%

Table 9 – 50K Thermistor Resistance Values

TEMPERATURE (°C)	RESISTANCE (K OHMS)
25	50.15 +/- 5.0%
75	7.565 +/- 3.0%
125	1.7 +/- 1.4%

If the outdoor air or coil thermistor should fail, the control will flash the appropriate fault code (see [Table 11](#).)

IMPORTANT: The OAT, OCT/LLT, OST, and ODT thermistors should be factory mounted in the final locations. Check to ensure thermistors are mounted properly (See [Fig. 32](#), [Fig. 33](#) and [Fig. 34](#)).

Outdoor Air Temperature (OAT)

The OAT is a 10K thermistor used for multiple system operations. It provides the outdoor air temperature to the primary control module and Infinity® System Control. It is essential for controlling the system and is used in almost all modes of operation. The sensor is mounted in the control box per [Fig. 32](#). See [Table 8](#) for proper resistances.

Outdoor Air Temperature Thermistor (OAT) must be rotated and locked in place with spherical nib end facing towards the front of the control box.

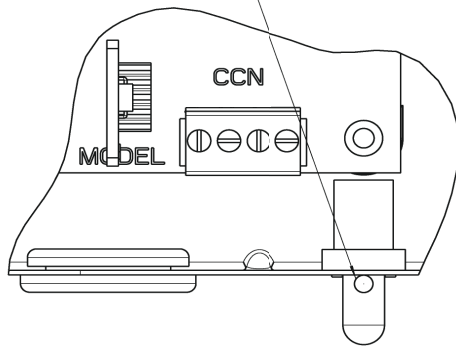

Fig. 32 – OAT Thermistor Mounting Location

A230575

! WARNING

PERSONAL INJURY AND/OR PROPERTY DAMAGE HAZARD

Failure to follow this warning could result in personal injury and/or property damage.

The appliance shall be stored in a room without continuously operating ignition sources (for example: open flames, an operating gas appliance or an operating electric heater. Do not pierce or burn.

Be aware that refrigerants do not contain an odor.

Outdoor Coil Temperature (OCT-HP)

The OCT-HP Thermistor is a 10K thermistor used for multiple system operations. This sensor is connected to the PCM through a shared 5-pin connector with OAT-HP and provides the coil temperature to the primary control module and Infinity® System Control. It is used for low ambient operation, defrost control, and other system operations. The sensor must be securely mounted to the stub tube on the outdoor coil. Note that there is only one stub tube used and on most units it is the bottom circuit. See Fig. 33 for proper placement. See Table 8 for proper resistances.

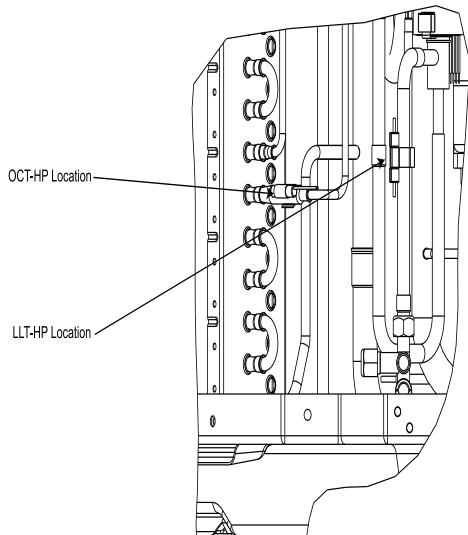

Fig. 33 – OCT-HP and LLT-HP Thermistor Mounting Locations

A240360

Liquid Line Temperature (LLT-HP)

The LLT-HP is a 10K thermistor used for multiple system operations. LLT-HP is connected to the PCM through a separate 3-pin connector and provides to the primary control module and Infinity® System Control. It is used for heating control and subcooling calculation during charging. The sensor must be securely mounted to the liquid tube in between the liquid service valve and the EXV. See Fig. 34 for proper placement. See Table 8 for proper resistances.

Outdoor Suction Temperature (OST)

The OST is a 10K thermistor used for assisting in EXV control and must be secured on the suction tube and aligned longitudinally to the vertical surface of the tube axis (see Fig. 34). See Table 8 for proper resistances.

Outdoor Discharge Line Temperature (ODT)

The ODT is a 50k thermistor used for determining discharge superheat and protecting the compressor from over-temperature operation. Proper mounting is required to reduce the influence of ambient temperature and provide accurate tube temperature. ODT is located on the compressor discharge stub-out (see Fig. 34) and should be inside the compressor sound blanket.. See Table 9 for proper resistances.

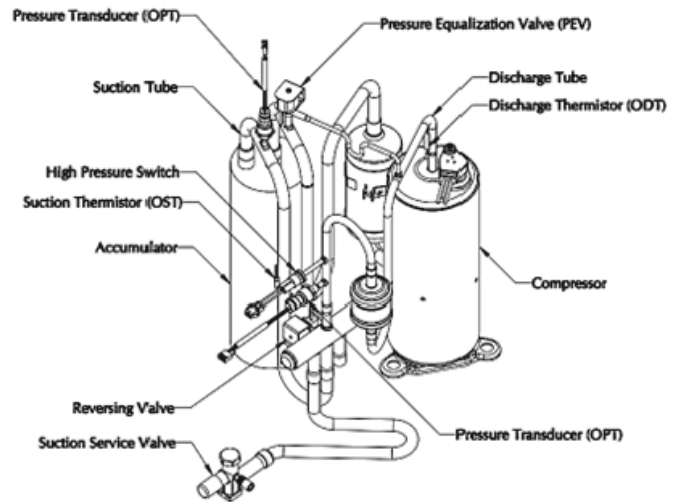

Fig. 34 – OST Thermistor and ODT Thermistor Mounting Locations

A230573

! CAUTION

EQUIPMENT DAMAGE HAZARD

Failure to follow this caution may result in equipment damage and/or improper operation.

In order to minimize the ambient influence, make sure the thermistor curved surface hugs the pipe surface and is secured tight using the wire tie fished through the original slot, insulating polymer body.

Failed Thermistor Default Operation

Factory defaults have been provided in the event of failure of any of the thermistors.

If the OAT sensor fails, the outdoor unit will operate at a fixed speed. The value of OST will be substituted for OAT when running in heating, and the value of OCT-HP will be reported when not running or running in cooling.

If the OCT-HP sensor fails, defrost will occur at a 60 minute time interval and run for 10 minutes during heating operation. Saturated suction temperature will be substituted for OCT-HP during heating operation, and discharge temperature will be substituted during cooling operation.

If the ODT sensor fails, the outdoor unit will operate at a fixed speed and a value of 47°F will be substituted.

If the OST sensor fails, the outdoor unit will not operate in heating, but will continue to operate in cooling. A value of 47°F will be substituted.

If the LLT-HP sensor fails, subcooling calculation during charging mode will not be available.

Variable Speed Compressor Winding Resistance

This compressor operates with 3-phase variable frequency PWM variable voltage. For troubleshooting certain fault codes related to compressor resistances, follow these steps:

1. Disconnect compressor power leads from the VFD terminals, U (YEL), V (RED), and W (BLK).
2. Measure the resistance between YEL to RED, YEL to BLK, and RED to BLK and compare to [Table 10](#) values. Each resistance set should be equal.
3. Measure the resistance to ground for each lead.
4. If the resistances are correct then reconnect power leads to appropriate terminal.
5. If the resistances appear to be abnormal, it will be necessary to measure the resistance at the compressor fuse terminals.
6. Remove the sound blanket and harness plug, measure the resistances, and compare to [Table 10](#).
7. Reinstall compressor sound blanket making sure discharge line thermistor and compressor power harness are routed as they were from the factory.

Table 10 – Variable Speed Compressor Resistances
winding resistance at 68°F (20°F)

WINDING	24	36	48	60
Between terminals T1, T2, and T3	1.630	.460	0.424	0.424
Between terminal & ground	>1 mega OHM			

CAUTION

EQUIPMENT DAMAGE HAZARD

Failure to follow this caution may result in equipment damage and/or improper operation.

Do not use Meggar for measuring the winding resistance.

Fan Motor

The fan motor requires 5 wires connected to VFD for operation. These wires are: DC BUS, GND, +15V DC, VSP, FG. Note high voltage present on ALL wires because they are not earth or chassis ground referenced. Do not attempt to measure voltages while running. Fan speed is monitored by VFD and PCM continuously. If fan faults occur verify the fan blade rotates freely without obstruction. Ensure all electrical connections are secure and wires are undamaged.

Status Codes

[Table 11](#) shows the status codes flashed by the amber status light. Most system problems can be diagnosed by reading the status code as flashed by the amber status light on the control board.

The codes are flashed by a series of short and long flashes of the status light. The short flashes indicate the first digit in the status code, followed by long flashes indicating the second digit of the error code.

The short flash is 0.25 seconds ON and the long flash is 1.0 second ON. Time between flashes is 0.25 seconds. Time between short flash and first long flash is 1.0 second. Time between code repeating is 2.5 seconds with LED OFF.

Codes are easily read from Infinity® System Control or the 5x7 LED display on the PCM.

EXAMPLE:

3 short flashes followed by 2 long flashes indicates a 32 code. [Table 11](#) shows this to be low pressure switch open.

Status Code Recall Mode

Active status codes are stored in memory even when power is absent. The most recent flashing status code (highest priority active) can be recalled from memory via Status Code Recall Mode is accessed by shorting (use a clip wire) the “force defrost” connector (labeled J2 on the board, and then power ON the unit.

Please make sure the unit is turned OFF before shorting the pins. Status Code Recall Mode will continue as long as the “force defrost” terminals remain shorted. The unit will not attempt to heat or cool while the terminals remain shorted. Once the status code is read, power-down the unit and remove the short.

Table 11 – Diagnostic Code Table

SERVICE

Base	Expansion		Bluetooth®	Base	Expansion		Bluetooth®
	Fault*	Malfunction**			Fault*	Malfunction**	
13	82	53	System Control Upgrade Recommended	57	01	41	P1 Open
14	94		Line Voltage Low	57	02	42	P1 Shorted
15	94		Line Voltage High	57	43		P1 Sensor Malfunction
17	06		Bluetooth Communication Error	58	01	41	P2 Open
18	11		Indoor Coil Freeze Protection	58	02	42	P2 Shorted
24		58	5V PCM External Power Out of Range	58	43		P2 Sensor Malfunction
25		61	Invalid Model Configuration	61	41		Reversing Valve Solenoid Open
		62	Model Configuration Missing	61	13	53	Reversing Valve Timeout
	24		Model Configuration Changed	62	01		PEV Solenoid Open
26		63	VFD/Equipment Model Mismatch	64	41		EXV-H Phase Open (HP Only)
	27		PCM Reprogramming Failure	64	44		EXV-H Power Short to Ground (HP Only)
28	31		PCM EEPROM Write Failure	64	45		EXV-H Phase Short to Ground (HP Only)
		71	Fuse 1 Open (PEV / RVS)	66	41		VFD Control Relay Coil Open
31		72	Fuse 2 Open (LLV)	66	42		VFD Control Relay Coil Shorted
	11	58	Compressor High Pressure Limit	81	13	53	PFC Error
	16		High Pressure Switch Trip	81	14	54	Unbalanced PFCM Error
32		19	High Pressure Disable	81	58		VFD System Wiring Error
	15	55	Compressor Low Pressure Limit	82	11		VFD Line Current Speed Reduction
33		59	Low Pressure Disable	82	13	53	VFD Reset with Power Dropout
	15	55	Compressor Low Discharge Limit	82	15	55	VFD Shutdown with Power Dropout
34	11	58	Compressor High Temperature Limit	82	16	56	Low Voltage Shutdown
35	11	58	Compressor High Compression Limit	82	17	57	High Voltage Shutdown
36	15	55	Compressor Low Compression Limit	83	11		Compressor Current Limit 1 Speed Reduction
38		13	Compressor Starting Error	83	12		Compressor Current Limit 2 Speed Reduction
		54	Compressor No Pump	83	15	55	Compressor Current Limit 3 Shutdown
	18		High Differential Pressure Start Disable	83	16	56	Compressor Current Limit 4 Shutdown
	31	71	VFD Estimator Error	83	57		Compressor Underspeed Shutdown
39	13	53	Fan Start Error	84	11	58	VFD Heat Sink Overtemp
	14		Fan Speed Error	85	13	53	DC Under Voltage Shutdown
	15	55	Unexpected Fan Shutdown	85	14	54	DC Over Voltage Shutdown
		58	Fan Motor Error	86	06	46	VFD Communication Error
41	13		Defrost Overrun	87	13	53	VFD Initialization Error
44	13		PEV Timeout	87	15	55	Unexpected VFD Reset
51	01		OAT (Outdoor Air Temp) Sensor Open/Low Temp	87	27		VFD Reprogramming Failure
	02		OAT (Outdoor Air Temp) Sensor Shorted/High Temp	88	31	71	VFD Internal Error - Current Sensor
52	01		OCT-HP/LLT-AC (Outdoor Coil Temp(HP)/Liquid Line Temp (AC)) Sensor Open/Low Temp	88	32		VFD Internal Error - IPM Temp Sensor
	02		OCT-HP/LLT-AC (Outdoor Coil Temp(HP)/Liquid Line Temp (AC)) Sensor Shorted/High Temp	88	33	73	VFD Internal Error - DC Link Sensor
53	01	41	OST (Outdoor Suction Temp) Sensor Open/Low Temp	88	34	74	VFD Internal Error - PFCM Sensor A
	02	42	OST (Outdoor Suction Temp) Sensor Shorted/High Temp	88	35	75	VFD Internal Error - PFCM Sensor B
54	01		ODT (Outdoor Discharge Temp) Sensor Open/Low Temp	88	36	76	VFD Internal Error - Line Volt Sensor
	02		ODT (Outdoor Discharge Temp) Sensor Shorted/High Temp	88	37		VFD Internal Error - PFCM Temp Sensor
55	01		LLT-HP (Liquid Line Temp) Sensor Open/Low Temp (HP Only)	88	38	78	VFD Internal Error - DC Discharge
	02		LLT-HP (Liquid Line Temp) Sensor Shorted/High Temp (HP Only)	88	39	79	VFD Internal Fault - Microprocessor

*Fault indicates a condition that interrupts or limits but does not prevent equipment operation. Faults may be temporary/intermittent or permanent.
 **Malfunctions indicate a serious condition that significantly limits or prevents system operation. Malfunctions may be an escalation of a repetitive fault condition.



350391-101 REV.A

Table 12 – Malfunction Lockout Durations

Code	Title	Time
13-53	System Control Upgrade Required	Permanent
24-58	5V PCM External Power Out of Range	Duration of Event
25-61	Invalid Model Plug Malfunction	Duration of Event
25-62	Model Plug Missing Malfunction	Duration of Event
25-63	VFD Model Mismatch	Permanent*
28-71	Fuse 1 Open Malfunction	Permanent*
28-72	Fuse 2 Open Malfunction	Permanent*
31-58	Compressor High Pressure Limit Malfunction	2 hours
32-55	Compressor Low Pressure Limit Lockout	2 hours
32-59	Low Pressure Disable	Permanent*
33-55	Compressor Low Discharge Limit Lockout	2 hours
34-58	Compressor High Temperature Limit Malfunction	2 hours
35-58	Compressor High Compression Limit Malfunction	2 hours
36-55	Compressor Low Compression Limit Lockout	2 hours
38-53	Compressor Starting Malfunction	4 hours
38-54	Compressor No Pump	30 minutes
38-71	VFD Estimator Malfunction	4 hours
39-53	Fan Start Malfunction	1 hour
39-55	Unexpected Fan Shutdown Malfunction	4 hours
39-58	Fan Motor Malfunction	30 minutes
53-41	OST Open / Low Temp	Duration of Event
53-42	OST Shorted / High Temp	Duration of Event
57-41	P1 Open Malfunction	Duration of Event
57-42	P1 Shorted Malfunction	Duration of Event
57-43	P1 Sensor Malfunction	Permanent*
58-41	P2 Open Malfunction	Duration of Event
58-42	P2 Shorted Malfunction	Duration of Event
58-43	P2 Sensor Malfunction	Permanent*

* unlikely to clear on its own; see Service Manual for troubleshooting steps

Table 12 – Malfunction Lockout Durations (Continued)

Code	Title	Time
61-41	Reversing Valve Solenoid Open	Duration of Event
61-53	Reversing Valve Timeout Malfunction	2 hours
64-41	EXV-H Phase Open	Duration of Event
64-44	EXV-H Power Short to Ground	Duration of Event
64-45	EXV-H Phase Short to Ground	Duration of Event
66-41	VFD Control Relay Coil Open	Duration of Event
66-42	VFD Control Relay Coil Shorted	Duration of Event
81-53	PFC Malfunction	2 hour
81-54	Unbalanced PFCM Malfunction	4 hours
81-58	VFD System Wiring Error	4 hours
82-53	VFD Reset with Power Dropout Malfunction	2 hour
82-55	VFD Shutdown with Power Dropout Malfunction	2 hours
82-56	Low Voltage Shutdown Malfunction	2 hour
82-57	Line Over Voltage Malfunction	2 hour
83-55	Compressor Current Limit 3 Lockout	2 hours
83-56	Compressor Current Limit 4 Lockout	2 hours
83-57	Compressor Under speed Shutdown	1 hour
84-58	VFD Overtemp Malfunction	2 hours
85-53	DC Under Voltage Malfunction	2 hour
85-54	DC Over Voltage Malfunction	1 hour
86-46	VFD Communication Malfunction	1 hour
87-53	VFD Initialization Malfunction	4 hours
88-55	Unexpected VFD Reset Malfunction	2 hour
88-71	VFD Internal Malfunction - Current Sensor	4 hours
88-73	VFD Internal Malfunction - DC Link Sensor	4 hours
88-74	VFD Internal Malfunction - PFCM Sensor A	4 hours
88-75	VFD Internal Malfunction - PFCM Sensor B	4 hours
88-76	VFD Internal Malfunction - Line Volt Sensor	4 hours
88-78	VFD Internal Malfunction - DC Discharge	4 hours
88-79	VFD Internal Malfunction - Microprocessor	4 hours

FINAL CHECKS

IMPORTANT: Before leaving job, be sure to do the following:

1. Ensure that all wiring is routed away from tubing and sheet metal edges to prevent rub-through or wire pinching.
2. Ensure all thermistors are making good contact with the tubes they are mounted to.
3. Record final charge on the outdoor unit charging label with permanent and legible writing.
4. Ensure that all wiring and tubing is secure in unit before adding panels and covers. Securely fasten all panels and covers.
5. Tighten service valve stem caps to 1/12-turn past finger tight.
6. Re-install red service port caps.
7. Leave Users Manual with owner. Explain system operation and periodic maintenance requirements outlined in manual.
8. Fill out Dealer Installation Checklist and place in customer file.

REPAIRING REFRIGERANT CIRCUIT

When breaking into the refrigerant circuit to make repairs, or for any other purpose, the following procedures shall be used.

1. Safely remove the refrigerant using a recovery pump certified for flammable refrigerants.
2. Purge the refrigerant circuit with an inert gas.
3. Evacuate the refrigerant circuit to 1500 microns.
4. Break vacuum with an inert gas purge of the refrigerant circuit ensuring that the outlet of the vacuum pump is not near a potential ignition source.
5. Open the circuit by cutting or brazing.

CARE AND MAINTENANCE

For continuing high performance and to minimize possible equipment failure, periodic maintenance must be performed on this equipment.

Frequency of maintenance may vary depending upon geographic areas, such as coastal applications. See Owner's Manual for information.

Puron Advance™ (R-454B) Refrigerant — Quick Reference Guide

- Be sure that servicing equipment and replacement components are designed to operate with R-454B refrigerant.
- Recovery cylinder service pressure rating must be 400 psig, DOT 4BA400 or DOT 4BW400.
- R-454B refrigerant systems should be charged with liquid refrigerant. Use a commercial type metering device in the manifold hose when charging into suction line with compressor operating.
- Leak detectors should be designed to detect R-454B refrigerant.
- R-454B refrigerant is compatible with POE and PVE oils only.
- Vacuum pumps will not remove moisture from oil.
- Do not use liquid-line filter driers with rated working pressures less than 600 psig.
- Do not leave R-454B suction line filter driers in line longer than 72 hours.
- Do not install a suction-line filter drier in liquid line.
- POE and PVE oils absorb moisture rapidly. Do not expose oil to atmosphere.
- POE and PVE oils may cause damage to certain plastics and roofing materials.
- Wrap all filter driers and service valves with wet cloth when brazing.
- A factory approved liquid-line filter drier is required on every unit.
- Do NOT use R-410A TXV. TXVs are not cross compatible between R-410A and R-454B.
- Do NOT convert a coil with a piston or R-410A metering device. Coils must come from the factory with an R-454B TXV and an A2L dissipation board already installed. Indoor unit is equipped with an R-410A TXV, it must be changed to a hard shutoff R-454B TXV.
- Never open system to atmosphere while it is under a vacuum.
- When system must be opened for service, recover refrigerant, evacuate then break vacuum with dry an inert gas and replace filter driers. Evacuate to 500 microns prior to recharging.
- Do not vent R-454B refrigerant into the atmosphere.
- Do not use capillary tube coils.
- Observe all **warnings**, **cautions**, and **bold** text.
- All indoor coils must be installed with a hard shutoff R-454B TXV metering device in long line applications.

Training

My Learning Center is your central location for professional residential HVAC training resources that help strengthen careers and businesses. We believe in providing high quality learning experiences both online and in the classroom.

Access My Learning Center with your HVACpartners credentials at www.mlctraining.com. Please contact us a mylearning@carrier.com with questions.

The Bluetooth® word mark and logos are registered trademarks owned by Bluetooth SIG, Inc. and any use of such marks by Carrier Corporation is under license. Other trademarks and trade names are those of their respective owners.

